

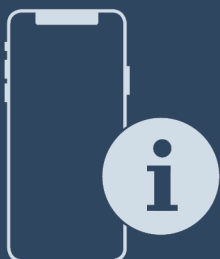

User Guide

Quality, Design and Innovation

















home.liebherr.com/fridge-manuals







LIEBHERR



Contents

1	Appliance at a glance	3
1.1	Scope of delivery.....	3
1.2	Overview of the appliance and features.....	3
1.3	Appliance range of use.....	3
1.4	Conformity.....	4
1.5	EPREL database.....	4
2	General safety instructions	4
3	Putting into operation	5
3.1	Switching on appliance.....	5
3.2	Inserting the components.....	5
4	Foods management	5
4.1	Storing food.....	5
4.2	Storage times.....	6
5	Saving energy	7
6	Controls	7
6.1	Controls and displays.....	7
6.1.1	Status display.....	7
6.1.2	Navigation.....	7
6.1.3	Operating structure.....	8
6.1.4	Display symbols.....	8
6.2	Control concept.....	8
6.2.1	Activating/deactivating the function.....	8
6.2.2	Selecting function value.....	8
6.2.3	Activating/deactivating settings.....	9
6.2.4	Go to the Customer menu.....	9
6.3	Functions.....	9
6.3.1	Temperature.....	9
	SuperCool.....	10
	SuperFrost.....	10
	PowerCool.....	10
6.3.5	Activating/deactivating the function.....	10
	E-Saver.....	10
6.4	Settings.....	10
	Connecting to the WLAN*.....	10
	Entry lock.....	11
	Display brightness.....	11
	Door alarm.....	11
	Temperature unit.....	11
	Info.....	11
	SabbathMode.....	11
6.4.8	Choose the setting.....	12
	D-Value.....	12
	Reminder.....	12
	Reset.....	12

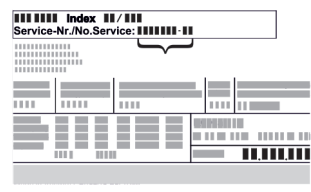
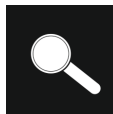
	Turn off appliance.....	12
6.5	Warnings.....	12
6.5.1	Message.....	12
6.5.2	DemoMode.....	13
7	Features	13
7.1	Door rack.....	13
7.2	Shelves.....	13
7.3	Dividing shelf.....	14
7.4	Adjustable bottle shelf.....	14
7.5	Drawers.....	14
7.6	Fruit & Vegetable safe cover.....	15
7.7	Adjusting the moisture levels.....	16
7.8	EasyTwist-Ice*.....	16
7.9	VarioSpace.....	17
7.10	Accessories.....	17
8	Maintenance	17
8.1	FreshAir carbon filter.....	17
8.2	Defrosting the appliance.....	17
8.3	Cleaning the appliance.....	17
9	Customer help	19
9.1	Technical specifications.....	19
9.2	Operating noises.....	20
9.3	Technical fault.....	20
9.4	Customer Services.....	21
9.5	Model plate.....	21
10	Shutting down	22
11	Disposal	22

The manufacturer is continually working on the further development of all types and models. Please be aware that we reserve the right to make changes to the shape, equipment and technology.

Symbol	Explanation
	Read instructions Please read the information in these instructions carefully to understand all of the benefits of your new appliance.
	Full instructions on the internet The detailed instructions are available via the QR code on the front of these instructions, at home.liebherr.com/fridge-manuals or by entering the service number at home.liebherr.com/fridge-manuals . The service number can be found on the serial tag <i>Fig. ()</i> .
	 <p style="text-align: right;"><i>Fig. Example illustration</i></p>
	Check appliance Check all parts for transport damage. If you have any complaints, please contact your agent or customer service.
	Differences These instructions apply to a range of models, so differences are possible. Sections that apply to certain models only are marked with an asterisk (*).

Symbol	Explanation
	Instructions and results Instructions are marked with a ▶. Results are marked with a ▷.
	Installation videos Videos on installing appliances can be found on the Liebherr Domestic Appliances YouTube channel.

These operating instructions apply to:

CBN (sf)(pc)(bb) (e)(d)(c)	52..57..(i)
----------------------------	-------------

Note

If your appliance has an N in the appliance designation, it is a NoFrost appliance.

1 Appliance at a glance

1.1 Scope of delivery

Check all parts for damage during transport. If you have any complaints, please contact your retailer or Customer Services (see 9.4 Customer Services).

Your new appliance comes with the following parts:

- Standalone appliance
- Features (depending on the model)
- Installation materials (depending on the model)
- "Quick Start Guide"
- "Installation Guide"
- Service Brochure

1.2 Overview of the appliance and features

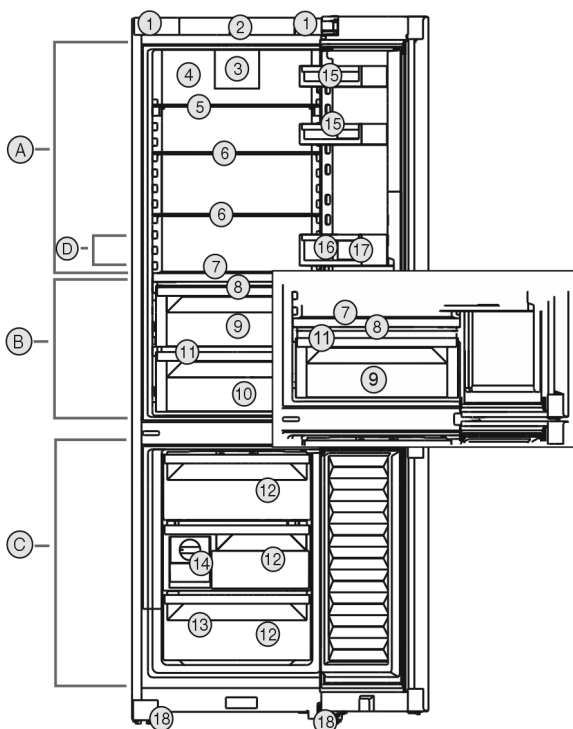

Fig. 1 Example illustration

Temperature range

- (A) Fridge compartment
- (B) BioFresh
- (C) Freezer compartment
- (D) Coldest zone

Features

- (1) Transport handles
- (2) Controls
- (3) Fan with FreshAiractivated charcoal filter
- (4) Stainless steel rear wall
- (5) Separable storage shelf
- (6) Storage shelf
- (7) Adjustable bottle shelf
- (8) Lid for Fruit & Vegetable-Safe
- (9) Fruit & Vegetable-Safe
- (10) Meat & Dairy-Safe*
- (11) Outlet
- (12) Freezer compartment
- (13) Serial tag
- (14) EasyTwist-Ice*
- (15) Can rack
- (16) Bottle rack
- (17) Bottle holder
- (18) Adjustable feet (front)

Note

▶ Shelves, drawers and baskets are arranged for optimum energy efficiency when the appliance is delivered. Changing how the shelves, for example, are inserted in the fridge compartment does not have any impact on energy consumption.

1.3 Appliance range of use

Intended use

The appliance is only suitable for cooling food products in a domestic or household-like environment. This includes, for example, use:

- in staff kitchens, bed and breakfast establishments,
- by guests in country houses, hotels, motels and other accommodation,
- for catering and similar services in the wholesale trade.

The appliance is not suitable as a built-in unit.

All other types of use are not permitted.

Foreseeable misuse

The following applications are expressly forbidden:

- Storing and refrigerating medicines, blood plasma, laboratory preparations or similar substances and products based on the Medical Device Directive 2007/47/EC
- Use in areas at risk of explosions

Misusing the appliance may lead to damage to the goods stored or they may spoil.

Climate classifications

Depending on the climate classification the appliance is designed to operate in restricted ambient temperatures. The climate classification applying to your appliance is printed on the rating plate.

Note

▶ Keep to the specified ambient temperatures in order to guarantee that the appliance works properly.

General safety instructions

Climate classification	for ambient temperatures of
SN	10 °C to 32 °C
N	16 °C to 32 °C
ST	16 °C to 38 °C
T	16 °C to 43 °C

1.4 Conformity

The refrigerant circuit has been tested for leaks. This device complies with the applicable safety regulations and with the directives 2014/35/EU, 2014/30/EU, 2009/125/EC, 2011/65/EU, 2010/30/EU and 2014/53/EU.

The full text of the EU Declaration of Conformity is available on the following website: www.Liebherr.com

The BioFresh compartment meets the requirements of a cold storage compartment as set out in DIN EN 62552:2020.

1.5 EPREL database

Details about energy labelling and ecodesign requirements will be available on the European product database (EPREL) from 1st March 2021. You can access the product database at the following link: <https://eprel.ec.europa.eu/> You will be asked to enter the model ID. You can find the model ID on the name-plate.

2 General safety instructions

Danger for the user:

- This device can be used by children and people with impaired physical, sensory or mental abilities or with a lack of experience and knowledge provided that they are supervised or have received instruction in the safe use of this device, and about the resulting hazards. Children must not play with this appliance. Cleaning and user maintenance work must not be carried out by children without adult supervision. Children aged between 3 and 8 are allowed to load and unload the appliance. Children below the age of 3 must be kept away from the appliance unless they are under continuous adult supervision.
- When disconnecting the appliance from the supply, always take hold of the plug. Do not pull the cable.
- In the event of a fault pull out the mains plug or deactivate the fuse.
- Do not damage the mains power cable. Do not operate the appliance with a defective mains power cable.
- Only customer service or other specially trained staff may repair or perform other operations on the appliance.

- Only assemble, connect and dispose of the appliance according to the instructions.
- Please keep these instructions in a safe place and pass them on to any subsequent owners.

Fire hazard:

- The coolant used (information on the model plate) is eco-friendly but also flammable. Any leaking coolant may ignite.
 - Do not damage the refrigerant circuit pipes.
 - Do not handle ignition sources inside the appliance.
 - Do not use electrical appliances inside the appliance (e.g. steam cleaners, heaters, ice cream makers, etc.).
 - If the refrigerant leaks: remove any naked flames or ignition sources from the vicinity of the leakage point. Properly air the room. Inform customer services.
- Do not store explosives or sprays using combustible propellants such as butane, propane, pentane, etc. in the appliance. To identify these spray cans, look for the list of contents printed on the can, or a flame symbol. Gases possibly escaping may ignite due to electrical components.
- Keep burning candles, lamps and other items with naked flames away from the appliance so that they do not set the appliance on fire.
- Please be sure to store alcoholic drinks or other packaging containing alcohol in tightly closed containers. Any alcohol that leaks out may be ignited by electrical components.

Danger of tipping and falling:

- Do not misuse the plinth, drawers, doors etc. as a step or for support. This applies particularly to children.

Danger of food poisoning:

- Do not consume food which has been stored too long.

Danger of frostbite, numbness and pain:

- Avoid prolonged skin contact with cold surfaces or refrigerated/frozen goods or take protective measures, e.g. wear use gloves.

Danger of injury and damage:

- Hot steam can lead to injury. Do not use electrical heating or steam cleaning equipment, open flames or defrosting sprays to defrost.
- Do not use sharp implements to remove the ice.

Symbols on the appliance:



The symbol can be located on the compressor. It refers to the oil in the compressor and indicates the following danger: Swallowing or inhaling can be fatal. This is only relevant for recycling. There is no danger in normal operation.



This symbol is found on the compressor and indicates the danger of flammable materials. Do not remove the sticker.



A sticker to this effect may be applied to the rear of the appliance. It refers to the foam-padded panels in the door and/or the housing. This is only relevant for recycling. Do not remove the sticker.

Please observe the specific information in the other sections:

	DANGER	identifies a situation involving direct danger which, if not obviated, may result in death or severe bodily injury.
	WARNING	identifies a dangerous situation which, if not obviated, may result in death or severe bodily injury.
	CAUTION	identifies a dangerous situation which, if not obviated, may result in minor or medium bodily injury.
	NOTICE	identifies a dangerous situation which, if not obviated, may result in damage to property.
	Note	It contains useful instructions and tips.

3 Putting into operation

3.1 Switching on appliance

Ensure that the following conditions are met:

- Appliance is set up and connected according to installation instructions.
- All adhesive strips, adhesive and protective films as well as transport safety devices in and on the appliance are removed.
- All marketing leaflets are removed from the drawers.
- ▶ Switch on the appliance via the control panel next to the display.

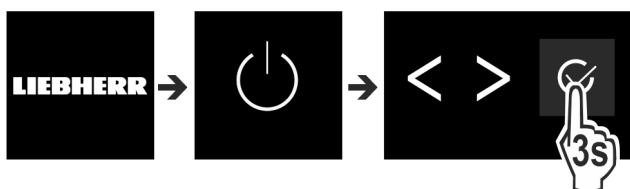

Fig. 2

- ▶ The status screen appears.
- ▶ If DemoMode is displayed after switching on the appliance, DemoMode can be deactivated within the next 5 minutes.

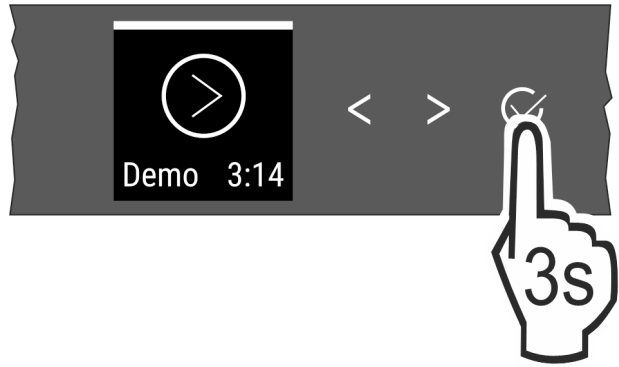

Fig. 3

- ▶ Press confirmation next to the display for 3 seconds.
- ▷ DemoMode is deactivated.

Note

The manufacturer recommends:

- ▶ Storing food: wait approx. 6 hours for the set temperature to be reached.
- ▶ Store **frozen produce** at -18 °C or colder.

3.2 Inserting the components

- ▶ Insert the supplied components to make the most of your appliance.
- ▶ Purchase and install the SmartDevice Box (see <https://smartdevice.liebherr.com/install>).*
- ▶ Install the SmartDevice app (see <https://apps.home.liebherr.com/>).

Note

You can purchase accessories from the [Liebherr household appliance store](http://home.liebherr.com) (home.liebherr.com).

4 Foods management

4.1 Storing food



WARNING

Risk of fire

- ▶ Do not use any electrical appliances in the food area of the appliance unless recommended by the manufacturer.

Note

The energy consumption increases and the cooling power goes down if ventilation is not sufficient.

- ▶ Always keep air slots clear.

When storing food, always observe the following:

- Air vents on the inside rear wall are unobstructed.
- Food is in sealed packaging.
- Foods that easily absorb or give off smell or taste are stored in sealed containers or covered.
- Raw meat and fish are in clean, sealed containers to prevent them coming into contact with or dripping onto other foods.
- Liquids are in sealed containers.
- Foods are not stored too closely together, as the air needs to circulate.

Note

Failure to follow these guidelines can lead to food perishing.

4.1.1 Fridge section

The natural air circulation creates a range of temperatures.

Foods management

Arrange your food as follows:

- ▶ In the top section and in the door: butter and cheese, preserves and tubes.
- ▶ In the coldest zone *Fig. 1 (D)*: easily perishable food such as prepared meals.

4.1.2 BioFresh

BioFresh helps certain fresh foods stay fresh for longer compared to conventional cooling methods.

In the case of foods with a minimum shelf life, the date indicated on the packaging still applies.

If the temperature drops below 0 °C, foods can freeze.

Note

Store cold-sensitive fruit and vegetables such as cucumbers, aubergines, courgettes and tropical fruit in the cooling section.

Fruit & Vegetable-Safe

This provides a fresh storage climate with the lid closed. A moist climate is suitable for storing loose foods with a high moisture content (e.g. salad, vegetables, fruit).

The air moisture in the compartment depends on the moisture content of the items being stored and the number of times the door is opened. You can adjust the air moisture.

Arrange your food as follows:

- ▶ Store your loose fruit and vegetables.
- ▶ Excessive air moisture: Regulate the air humidity (see 7.7 Adjusting the moisture levels).

Meat & Dairy-Safe

Here a relatively dry storage climate is set. A dry climate is great for dry or packaged foods (e.g. dairy products, meat, fish, sausage).

Arrange your food as follows:

- ▶ Place the dry or packaged foods inside.

4.1.3 Freezer compartment

This provides a dry, frosty storage climate at -18 °C. A frosty climate is great for storing frozen food and frozen goods for several months, making ice cubes and freezing fresh food.

Freezing food

You can freeze as many kilograms of fresh food within 24 hours as indicated on the nameplate (see 9.5 Model plate) under "freezing capacity ... kg/24h".

So that the food is rapidly frozen through to the core, keep to the following quantities per pack:

- Fruit, vegetables up to 1 kg
- Meat up to 2.5 kg

Before freezing goods, please make sure of the following:

- SuperFrost is activated (see 6.3 Functions) when the amount of food to freeze exceeds approx. 2 kg.
- With a small amount to freeze: SuperFrost is on for about 6 hours beforehand.
- With a maximum amount to freeze: SuperFrost is on for about 24 hours beforehand.

Arrange your food as follows:



CAUTION

Risk of injury from glass fragments!
Drink bottles and cans may explode if frozen. This applies particularly to carbonated drinks.

- ▶ Only freeze drink bottles and cans when using the *bottle timer* function.

With a small amount to freeze:

- ▶ Put packaged food in the top drawers.
With a maximum amount to freeze:
- ▶ Remove the top drawers and place the packaged food onto the top shelves.
With the maximum frozen quantities:
- ▶ Once SuperFrost turns off automatically, place the food in the drawer compartment.

Defrost the food

- In the fridge
- In the microwave
- In the stove/oven
- At room temperature



WARNING

Risk of food poisoning!

- ▶ Do not re-freeze thawed food.

- ▶ Only take out the food you need at the time.
- ▶ Cook defrosted food as soon as possible.

4.2 Storage times

Refer to the specified storage times as a guide.

In the case of foods with a minimum shelf life, the date indicated on the packaging still applies.

4.2.1 Fridge section

Always follow the best-before date stated on the packaging.

4.2.2 BioFresh

Note

You can also use the guides in the BioFresh app <https://home.liebherr.com/de/deu/service/apps/landing-page-apps-emea.html>.

Recommended storage periods in the Meat & Dairy-Safe		
Butter	at 1 °C	up to 90 days
Hard cheese	at 1 °C	up to 110 days
Milk	at 1 °C	up to 12 days
Sausage, cold meats	at 1 °C	up to 8 days
Poultry	at 1 °C	up to 6 days
Pork	at 1 °C	up to 6 days
Beef	at 1 °C	up to 6 days
Game	at 1 °C	up to 6 days

Note

- ▶ Remember that high-protein foods perish quicker; shellfish and crustaceans do not last as long as fish, and fish does not last as long as meat.

Recommended storage periods in the Fruit & Vegetable-Safe		
Vegetables, salads		
Artichokes	at 1 °C	up to 14 days
Celery	at 1 °C	up to 28 days
Cauliflower	at 1 °C	up to 21 days
Broccoli	at 1 °C	up to 13 days
Chicory	at 1 °C	up to 27 days

Recommended storage periods in the Fruit & Vegetable-Safe

Lettuce	at 1 °C	up to 19 days
Peas	at 1 °C	up to 14 days
Kale	at 1 °C	up to 14 days
Carrots	at 1 °C	up to 80 days
Garlic	at 1 °C	up to 160 days
Turnip	at 1 °C	up to 14 days
Lettuce	at 1 °C	up to 13 days
Herbs	at 1 °C	up to 13 days
Leeks	at 1 °C	up to 29 days
Mushrooms	at 1 °C	up to 7 days
Radishes	at 1 °C	up to 10 days
Brussels sprouts	at 1 °C	up to 20 days
Asparagus	at 1 °C	up to 18 days
Spinach	at 1 °C	up to 13 days
Savoy	at 1 °C	up to 20 days
Fruit		
Apricots	at 1 °C	up to 13 days
Apples	at 1 °C	up to 80 days
Pears	at 1 °C	up to 55 days
Blackberries	at 1 °C	up to 3 days
Dates	at 1 °C	up to 180 days
Strawberries	at 1 °C	up to 7 days
Figs	at 1 °C	up to 7 days
Blueberries	at 1 °C	up to 9 days
Raspberries	at 1 °C	up to 3 days
Currants	at 1 °C	up to 7 days
Sweet cherries	at 1 °C	up to 14 days
Kiwis	at 1 °C	up to 80 days
Peaches	at 1 °C	up to 13 days
Plums	at 1 °C	up to 20 days
Cranberries	at 1 °C	up to 60 days
Rhubarb	at 1 °C	up to 13 days
Gooseberries	at 1 °C	up to 13 days
Grapes	at 1 °C	up to 29 days

4.2.3 Freezer compartment

Recommended storage period for various types of food		
Ice cream	at -18 °C	2 to 6 months
Sausages, ham	at -18 °C	2 to 3 months
Bread, baked goods	at -18 °C	2 to 6 months
Game, pork	at -18 °C	6 to 9 months
Fatty fish	at -18 °C	2 to 6 months
Lean fish	at -18 °C	6 to 8 months
Cheese	at -18 °C	2 to 6 months

Recommended storage period for various types of food		
Poultry, beef	at -18 °C	6 to 12 months
Vegetables, fruit	at -18 °C	6 to 12 months

5 Saving energy

- Pay attention to good ventilation. Do not cover ventilation holes or grids.
- Always keep the fan air slits clear.
- Do not install the appliance in direct sunlight, next to an oven, radiator or similar.
- Energy consumption depends on the installation conditions, e.g. the ambient temperature (see 1.3 Appliance range of use) . A warmer ambient temperature can increase the energy consumption.
- Open the appliance for as short a time as possible.
- The lower the temperature is set the higher the energy consumption.
- Sort your food: home.liebherr.com/food.
- Keep all food properly packed and covered. This prevents frost from forming.
- Only take food out for as long as necessary so that it doesn't warm up too much.
- Inserting warm food: allow to cool down to room temperature first.
- Thaw frozen food in the refrigerator.
- For longer periods of absence, use HolidayMode .

6 Controls

6.1 Controls and displays

The display provides a quick overview of the temperature setting and the status of functions and settings. You can control the functions and settings either by deactivating/activating them or by selecting a value.

6.1.1 Status display

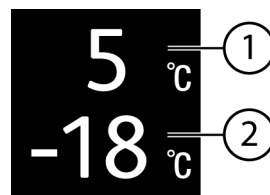

Fig. 4

(1) Temperature display of the fridge section

(2) Freezer compartment temperature display

6.1.2 Navigation

Navigate in the menu to access the individual functions. An audible signal sounds after confirming a function or setting. If no selection is made after 10 seconds the display switches to the Status screen.

The appliance is operated with the buttons next to the display.



Fig. 5

(1) Navigation arrow left/right

(2) Confirm

Controls

Navigation arrow left/right Fig. 5 (1):

- Navigating in the menu. After the last menu page, it goes back to the first one.

Confirm Fig. 5 (2):

- Activating/deactivating a function.
- Open a submenu.
- Confirm a selection. After confirmation the display switches back to the menu.

Back to Status display: in the fastest manner:

- Close and open the door.
- or wait 10 seconds. The display switches to the Status display.

6.1.3 Operating structure

The controls are explained by a template. The display changes depending on the function or settings.

Menus without a submenu

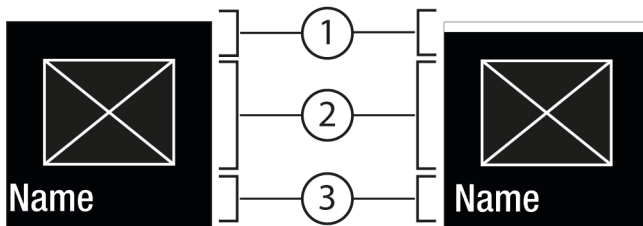

Fig. 6

- (1) Status deactivated / status activated white bar in the top area
- (2) Symbol or activated value
- (3) Menu: Function name or menu: Setting name

Menus with a submenu

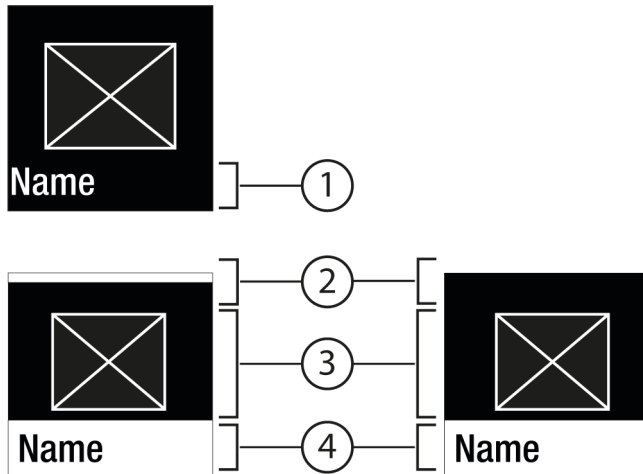

Fig. 7

- (1) Menu: Function name or menu: Setting name
 - (2) Status
 - (3) Symbol or activated value
 - (4) Submenu: function name or submenu: Setting name
- (2) off / on

You can navigation as follows:

- Press the left/right Fig. 5 (1) arrow to navigate.
- Press Confirm Fig. 5 (2) to open the submenu Fig. 7 (4).
 - Press the left/right Fig. 5 (1) arrow to navigate.
 - Set a new value: Press Confirm Fig. 5 (2) to select an active value Fig. 6 (1).
 - Back to the menu: Press Confirm Fig. 5 (2) to select the active value Fig. 6 (2).

6.1.4 Display symbols

Display symbols provide information on the current appliance status:

Symbol	Appliance status
	Standby The appliance or temperature zone is switched off.
	Flashing number Appliance is working. Temperature flashes until the set value is reached.
	Flashing symbol Appliance is working. Setting is made.
	Bar grows steadily Function is activated.

6.2 Control concept

6.2.1 Activating/deactivating the function

You can activate/deactivate the following functions:

Symbol	Function
	SuperCool ^x
	PowerCool ^x
	SuperFrost ^x
	HolidayMode
	E-Saver

^x When a function is on, the appliance works harder. This means the appliance could make louder noises and consume more energy.

- ▶ Press the navigation arrows Fig. 5 (1) until the appears.
- ▶ Press Confirm Fig. 5 (2).
- ▷ You hear the confirmation tone.
- ▷ Status appears in the menu.
- ▷ Function is on/off.

6.2.2 Selecting function value

With the following functions you can set a value in the submenu:

Symbol	Function
	Cool: Setting the temperature Turn on/off the temperature zone
	Freeze: Setting the temperature Switch the appliance on/off

- ▶ Tap the navigation arrows Fig. 5 (1) repeatedly until the function is displayed.
- ▶ Press Confirm Fig. 5 (2).
- ▶ Select the setting value with the navigation arrows Fig. 5 (1).

Setting the temperature







- ▶ Press Confirm *Fig. 5 (2)*.
- ▷ You hear the confirmation tone.
- ▷ Status: On *Fig. 6 (1)* appears briefly in the submenu *Fig. 7 (4)*.
- ▷ Display switches back to the menu.

Switching the temperature zone on/off

- ▶ To Confirm, press for 3 seconds.
- ▷ You hear the confirmation tone.
- ▷ Display returns to the Status screen.

6.2.3 Activating/deactivating settings

You can activate/deactivate the following settings:

Symbol	Setting
	WiFi ¹
	Entry lock ²
	SabbathMode ²
	Reminders ¹
	Reset ²
	Off ²

- ▶ Tap the navigation arrows *Fig. 5 (1)* repeatedly until the settings appear. 
- ▶ Press Confirm *Fig. 5 (2)*.
- ▶ Tap the navigation arrows *Fig. 5 (1)* repeatedly until the desired setting is displayed.

¹ Activate setting (shortpress)



- ▶ Press Confirm *Fig. 5 (2)*.
- ▷ You hear the confirmation tone.
- ▷ Status appears in the menu.
- ▷ Setting is on / off.



² Activate setting (longpress)

- ▶ To Confirm *Fig. 5 (2)*, press for 3 seconds.
- ▷ You hear the confirmation tone.
- ▷ Status appears in the menu.
- ▷ Display changes.

6.2.4 Go to the Customer menu

You can see the following settings in the Customer menu:

Symbol	Function
	D-Value ¹
	Software

- ▶ Press the navigation arrows *Fig. 5 (1)* repeatedly until the settings  appear.
- ▶ Press Confirm *Fig. 5 (2)*.
- ▶ Press the navigation arrows *Fig. 5 (1)* repeatedly until the appliance information  appears in the display.
- ▶ Press Confirm *Fig. 5 (2)*.
- ▶ Enter the numerical code 151.
- ▷ The customer menu appears.

- ▶ Press the navigation arrows *Fig. 5 (1)* repeatedly in the customer menu until the desired setting appears.

¹ Select the value

- ▶ Press Confirm *Fig. 5 (2)*.
- ▷ You hear the confirmation tone.
- ▷ Status appears briefly in the display.
- ▷ Display switches back to the menu.

² Activate the setting



- ▶ To Confirm *Fig. 5 (2)*, press for 3 seconds.
- ▷ You hear the confirmation tone.
- ▷ Status appears on the display.
- ▷ The symbol flashes as long as the appliance is working.

6.3 Functions

Temperature

The temperature depends on the following factors:

- The amount of times the door is opened
- How long the door is open for
- The room temperature of the installation site
- The type, temperature and amount of food

Temperature zone	Recommended setting
 5 °C Fridge section	5 °C
 -18 °C Freezer compartment	-18 °C
 0 °C BioFresh	

Setting the temperature

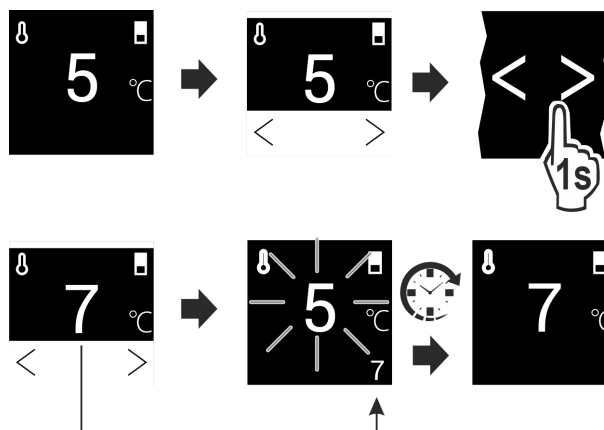



Fig. 8

- ▶ Set the value. (see 6.2 Control concept) .
- ▷ Set temperature is shown at the bottom right of the display.

Switching off a temperature zone

- You can switch the fridge compartment off separately. Switching off the freezer section turns off all the temperature zones.
- ▶ Set the value. (see 6.2 Control concept) .
 - ▷  appears.

Setting the temperature in the BioFresh

You can set the temperature using the **BioFresh B-Value** in the customer menu.

Controls



SuperCool

This function selects the lowest cooling temperature. This gives you colder storage temperatures.

This function is relevant to the fridge section *Fig. 1 (A)*

Use:

- Cool large amounts of food quickly.

Activating/deactivating the function

- ▶ Using the fridge section: activate the function when you add the goods.
- ▶ Activating/deactivating (see 6.2 Control concept) .
- or-
- ▶ Activating/deactivating in the Liebherr SmartDevice-App.*

The function automatically turns off. The appliance goes back to normal mode. The temperature adjusts itself to the set level.



SuperFrost

This function selects the lowest freezing temperature. This gives you colder storage temperatures.

This function refers to the freezer section *Fig. 1 (C)*.

Use:

- For storing more than 2 kg fresh food every day.
- Freezing fresh food quickly to the core.
- Increasing the cold reserves in the stored goods before defrosting the appliance.

Activating/deactivating the function

With a small amount to freeze:

- ▶ Activate 6 hours before use.
- With a maximum amount to freeze:
- ▶ Activate 24 hours before use.
- ▶ Activating/deactivating (see 6.2 Control concept) .

-or-

- ▶ Activating/deactivating in the [Liebherr SmartDevice app](#).*

The function automatically turns off. The appliance goes back to normal mode. The temperature adjusts itself to the set level.



PowerCool

This function provides the perfect blanket temperature to cool your food.

This function refers to the fridge section *Fig. 1 (A)*.

Use:

- At higher room temperatures (from approx. 35 °C)
- When humidity is high e.g. on summer days
- When storing moist goods, to avoid condensation building up inside

Activating/deactivating the function

- ▶ Activating/deactivating (see 6.2 Control concept) .

Note

The fan can run even when function is deactivated. This ensures optimal temperature distribution in the appliance.

- ▷ Function activated: Energy consumption of the appliance is slightly increased.

This option offers an assortment of special functions and settings that are useful if you are having a party.

The following functions are on:

- *SuperCool*
- *SuperFrost*

All the functions can be adjusted flexibly and separately. Changes are discarded when the function turns off.



6.3.5 Activating/deactivating the function

- ▶ Activating/deactivating (see 6.2 Control concept) .
 - ▷ On: All functions are activated at the same time.
 - ▷ Deactivated: Previously set temperatures are restored.
- After 24 hours the function turns off automatically.



E-Saver

This function reduces energy consumption. If you activate this function, the cooling temperature increases.

Temperature zone	Recommended setting (see Temperature)	Temperature when E-Saver activated
 5 °C Fridge compartment	5 °C	7 °C
 -18 °C Freezer compartment	-18 °C	-16 °C

Use:

- Save energy.

Activating/deactivating the function

- ▶ Activating/deactivating (see 6.2 Control concept) .
- ▷ Activated: Higher temperatures are set in all temperature zones.
- ▷ Deactivated: Previously set temperatures are restored.

6.4 Settings



Connecting to the WLAN*

This setting connects the appliance to the internet. The connection is managed in the SmartDevice-Box. You can use the SmartDevice-App to add your appliance to a SmartHome-System. Use the SmartDevice-App or other compatible partner networks to enjoy advanced options and settings.

Note

The SmartDevice-Box is available from the [Liebherr Domestic Appliances Shop \(https://home.liebherr.com/shop/de/deu/smartdevicebox.html\)](https://home.liebherr.com/shop/de/deu/smartdevicebox.html).

You can find more information about the availability, prerequisites and the individual options on the Internet under <https://smartdevice.liebherr.com/install>.

Use:

- Manage the appliance with the SmartDevice-App or a compatible partner network.
- Enjoy advanced functions and settings.
- Check the current status of the appliance in the SmartDevice-App.

- The SmartDevice app is installed (see <https://apps.home.liebherr.com/>).

Setting up the connection

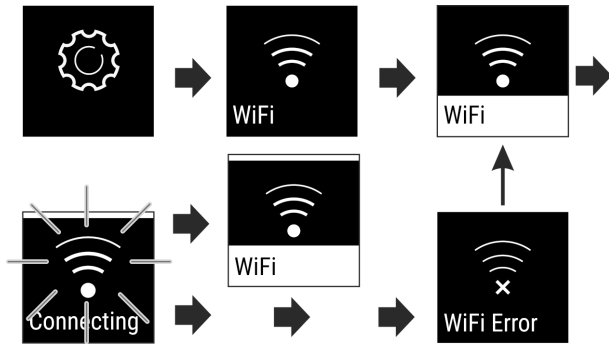

Fig. 9

- ▶ Activating the setting (see 6.2 Control concept) .
- ▷ The connection is set up: Status: on Fig. 6 (1) and WiFi connecting appears. The symbol flashes.
- ▷ The connection is set up: Status: on Fig. 6 (1) appears.
- ▷ The connection failed: Status and Connect appears. The symbol appears permanently.

Disconnecting the appliance

- ▶ Deactivate the setting (see 6.2 Control concept) .

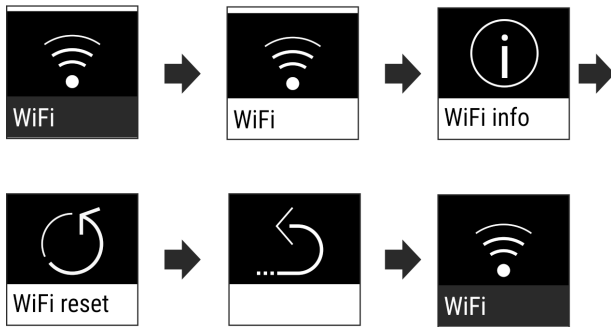



Fig. 10

- ▷ There is no connection: The symbol  is displayed constantly.

Restoring the connection

- ▶ Restore settings (see 6.2 Control concept) .

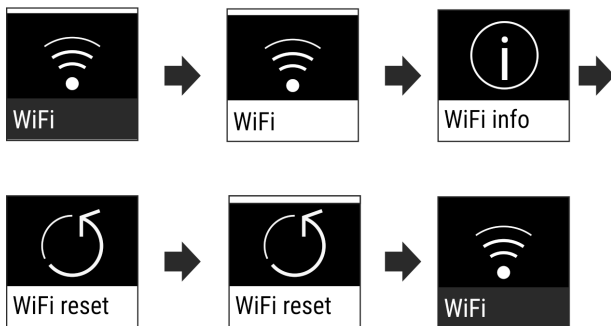

Fig. 11

- ▷ Connection and other settings are restored to factory settings.

Entry lock

This setting prevents unintentional use of the appliance, e.g. by children.

Use:

- Avoid settings being changed unintentionally.
- Avoid the appliance being switched off unintentionally.
- Avoid the temperature being changed unintentionally.

Activating/deactivating settings

- ▶ Activating/deactivating. (see 6.2 Control concept)



Display brightness

Set the brightness level of the display.

You can set the following brightness levels:

- 40%
- 60%
- 80%
- 100%

Choose the setting

- ▶ Set the level (see 6.2 Control concept) .

Door alarm

Set the time before the door alarm (see Close door) sounds.

The options are as follows:

- 1 min
- 2 min
- 3 min
- Off

Choose the setting

- ▶ Set the time (see 6.5 Warnings) .

Temperature unit

This setting enables you to switch between Celsius and Fahrenheit as the temperature unit.

Selecting the setting value

- ▶ Set the value (see 6.2 Control concept) .

Info

This setting allows the appliance information to be read out as well as access to the customer menu.

It provides the following information:

- Model name
- Index
- Serial number
- Service number

Show appliance data

- ▶ Tap the navigation arrows Fig. 5 (1) repeatedly until the  settings appear.
- ▶ Press Confirm Fig. 5 (2).
- ▶ Tap the navigation arrows Fig. 5 (1) repeatedly until the information is displayed.
- ▶ Read the appliance info.

SabbathMode

This setting meets the religious requirements on the Sabbath and Jewish festivals. Turn on SabbathMode to switch off

Controls

certain controls. This means you can use the appliance without anyone changing the settings.

You can find a list of Star-K-certified appliances at www.star-k.org/appliances.



WARNING

Danger of food poisoning.

If there is a power cut while the appliance is in SabbathMode, this message is not saved. Once power is restored, the appliance continues in SabbathMode. When this mode is over no message about the power cut is displayed on the temperature display.

If there was a power cut during SabbathMode:

- ▶ Check the food for quality. Do not eat the food if it has thawed.

What happens on the appliance when in SabbathMode:

- The Status display permanently shows SabbathMode.
- The display is locked for all functions apart from turning off SabbathMode.
- Any functions/settings that are already on, remain active.
- The display stays bright when the door is closed.
- Reminders are disabled. The set time intervals are also paused. This function is disabled in SabbathMode.
- Reminders and warnings are not displayed. There are no acoustic signals, and the display does not show warnings or settings such as temperature alarm or door alarm.
- The internal light is off.
- The defrost cycle only works for the specified time without taking account of fridge use.
- After a power cut the appliance automatically returns to SabbathMode.

Activating/deactivating SabbathMode

- ▶ To activate the function, click the arrows next to the display until you see Settings  in the menu and then confirm. The menu changes to show the available settings.
- ▶ Click the arrows next to the display until you see SabbathMode (Menora) appear. Confirm the symbol.
- ▷ A white bar appears in the top part of the display.
- ▷ SabbathMode is activated.

To deactivate this function, press the button for confirmation next to the display for 3 seconds.

SabbathMode is deactivated.

When delivered, the temperature in the BioFresh compartment is set to B5. The status indicator on the display shows the appropriate target temperature in the BioFresh.

You can change this value slightly if a higher or lower ambient temperature makes it necessary. When setting the value, note:

Value	Description
B1	Lowest temperature
B1-B4	The temperature can drop to under 0 °C, so food can freeze easily.
B5	Default temperature
B9	Highest temperature

BioFresh B-Value

6.4.8 Choose the setting

- ▶ Set the size in the Customer menu (see 6.2 Control concept).



D-Value

The *D-Value* is preset for your appliance and may not be changed.



Reminder

Reminders are given out acoustically by a beep and visually by a symbol in the display. The signal gets louder until the alert stops.



Replace FreshAir active carbon filter

This message appears when the air filter needs replacing.

- ▶ Change the air filter every six months.
- ▶ Confirm the message with OK.
- ▷ The service interval resets.
- ▷ The air filter guarantees the air quality in the fridge.

Activating the setting

- ▶ Activating/deactivating (see 6.2 Control concept).



Reset

This function resets all settings to the factory settings. All settings that you have made thus far will be reset to their original values.

Activating the setting

- ▶ Activate (see 6.2 Control concept).



Turn off appliance

This setting turns off the whole appliance.

Switching off the entire appliance

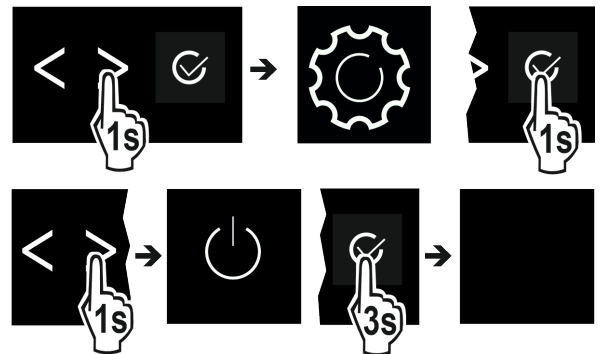

Fig. 12

- ▶ Activating/deactivating (see 6.2 Control concept).
- ▷ Off: Display goes black.

6.5 Warnings

Warnings are issued with an acoustic signal and visually with a symbol on the display. The signal gets louder until the alert stops.

6.5.1 Message



Close door

This message appears if the door is open for too long.

You can set how long it takes for this message to appear.

- ▶ Stop alarm: Confirm the message.

-or-

- ▶ Close the door.



Power cut

This message appears if the freezer temperature increased due to a power cut. After the power is restored, the appliance continues to work at the set temperature.

- ▶ Stop alarm: Confirm the message.
- ▷ Temperature alert appears (see Temperature alarm) .



Temperature alarm

This message appears if the freezer temperature does not match the set temperature.

Variations in temperature could be because:

- Hot, fresh food was inserted.
- Too much warm room air flowed in when rearranging and removing food.
- The power was cut off for a while.
- The appliance is faulty.

When the fault is eliminated the appliance continues to work at the set temperature.

- ▶ Confirm the display.
- ▷ The highest temperature is shown.
- ▶ Confirm display again.
- ▷ The status display is displayed.
- ▷ The current temperature is shown.



Error

This message appears if there is a fault with the appliance. An appliance component indicates a fault.

- ▶ Open the door.
- ▶ Note down the fault code.
- ▶ Confirm the message.
- ▷ The audible signal stops.
- ▷ The display switches to the Status screen.
- ▶ Close the door.
- ▶ Contact Customer Services (see 9.4 Customer Services) .

6.5.2 DemoMode

If “D” appears on the display, demo mode is on. This option is designed for retailers, as it turns off all the cooling functions.

Stopping DemoMode

If you see the following running in the display:

- ▶ Confirm the display within the countdown.
- ▷ DemoMode is off.
- If the timer is not running:
- ▶ Unplug the appliance.
- ▶ Plug the appliance in again.
- ▷ DemoMode is off.

7 Features

7.1 Door rack

7.1.1 Move/remove the door rack

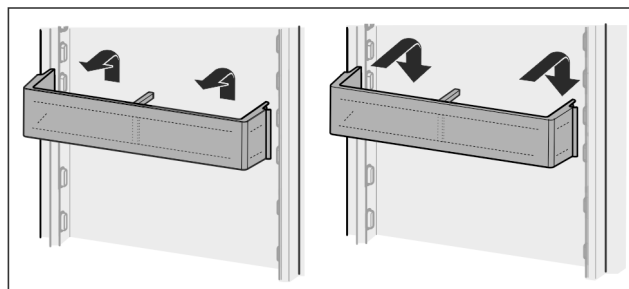

Fig. 13

- ▶ Slide the rack upwards.
- ▶ Pull forwards.
- ▶ Re-insert it in reverse order.

7.1.2 Disassembling the door rack

The door rack can be taken apart for cleaning.

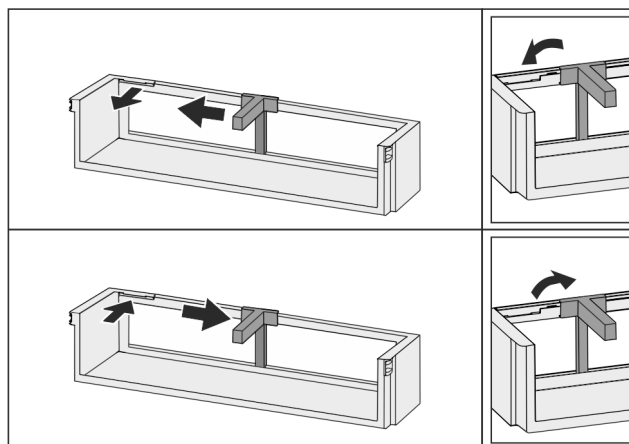

Fig. 14

- ▶ Disassemble the door rack.

7.2 Shelves

7.2.1 Adjusting/removing the shelves

The shelves are prevented from being pulled out accidentally by pull out stops.

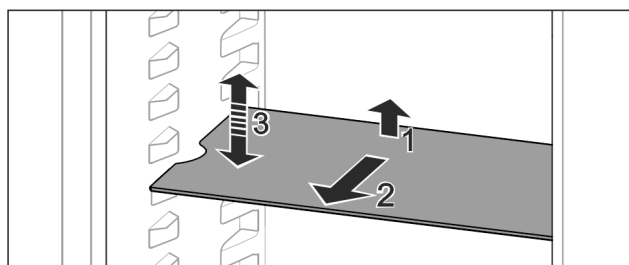

Fig. 15

- ▶ Lift the shelf and pull forward.
- ▷ Line up the side runner.
- ▶ Adjust the height of the shelf: Lift or lower it to the desired height and slide it in.

-or-

Features

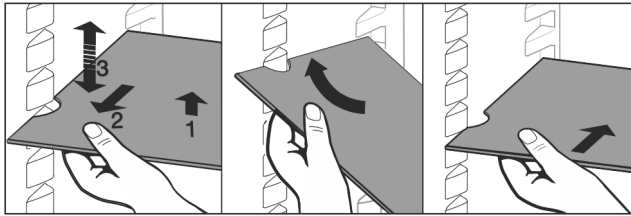

Fig. 16

- ▶ Remove the shelf completely: Pull it out to the front.
- ▶ Easier removal: Set the shelf at an angle.
- ▶ Insert the shelf again: Slide it in all the way.
- ▷ The pull-out stoppers point downwards.
- ▷ The pull-out stoppers are behind the front support.

7.3 Dividing shelf

7.3.1 Using the dividing shelf

The shelves are prevented from being pulled out accidentally by pull out stops.

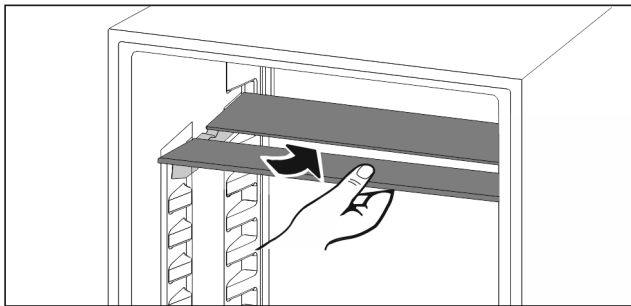

Fig. 17

- ▶ Push the dividing shelf underneath as shown.

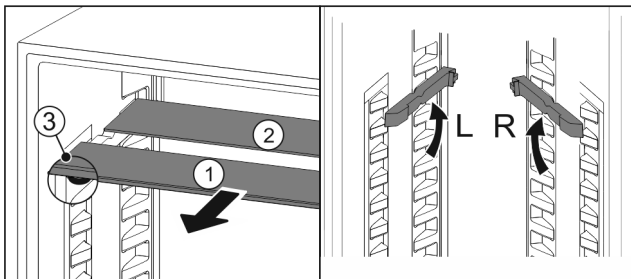

Fig. 18

Adjusting the height:

- ▶ Pull the glass panels out Fig. 18 (1) from the front, one at a time.
- ▶ Release the support rails and click in at the height you want.
- ▶ Slide in the glass panels one at a time.
- ▷ Flat pull-out stoppers at the front, right behind the support rails.
- ▷ High pull-out stoppers at the back.

Using both shelves:

- ▶ Hold the glass panel with one hand and pull it to the front.
- ▷ The glass panel Fig. 18 (1) and trim strip are at the front.
- ▷ The stops Fig. 18 (3) point down.

7.4 Adjustable bottle shelf

7.4.1 Using the bottle shelf

In the bottom of the fridge section you can either use the variable bottle shelf or the glass panel.

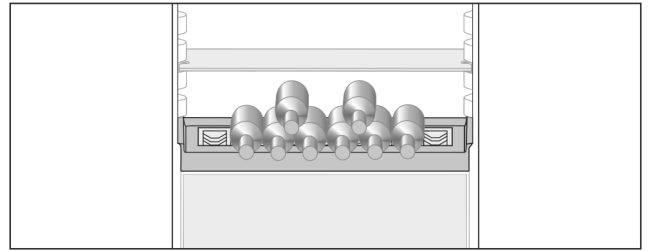

Fig. 19

- ▶ Remove the glass panel and store in a safe place.
- ▶ Lay bottles with their base towards the rear wall.

Note

- If the bottles are protruding over the front of the bottle shelf:
- ▶ Move the lower door rack up a place.

7.4.2 Removing the bottle shelf

You can remove the bottle shelf for cleaning.

- ▶ Remove the glass panel above the bottle shelf.

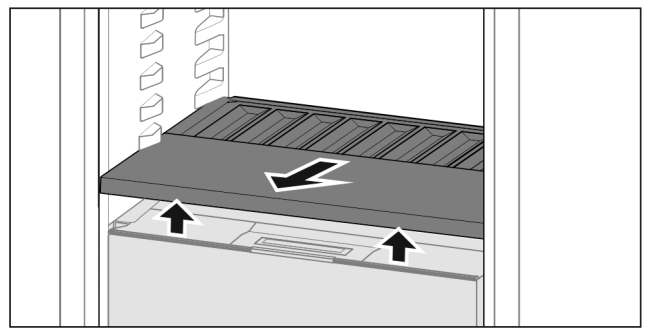

Fig. 20

- ▶ Lift the bottle shelf at the front and pull out.

Note

Liebherr recommends the following:

Do not place any goods on the drawer cover below.

7.4.3 Inserting the bottle shelf

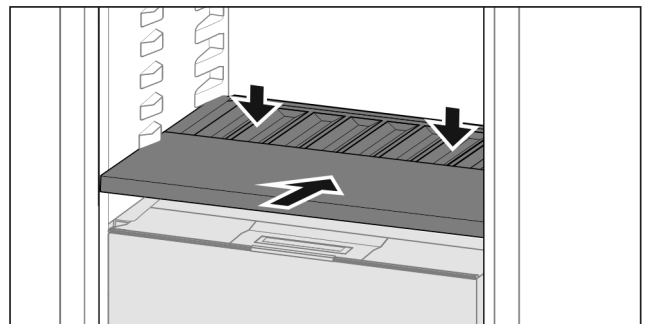

Fig. 21

- ▶ Slide in the bottle shelf until it engages and push down.

7.5 Drawers

Drawers can be removed for cleaning.

The shelves below can be used for storage until the drawers are replaced.

The way to remove/insert the drawers varies depending on the pull-out system. Your appliance can include various pull-out systems.

Note

The energy consumption increases and the cooling power goes down if ventilation is not sufficient.

- ▶ Leave the bottom drawer in the appliance!
- ▶ Always leave the fan air vents clear on the back wall!

7.5.1 Removing the drawer

Drawer on rails

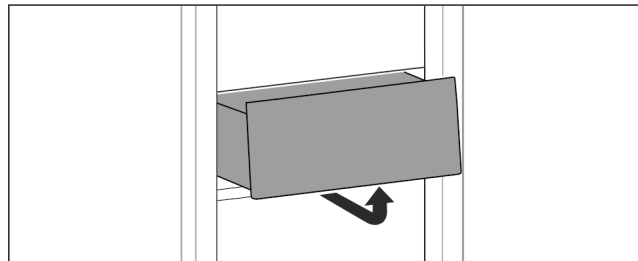

Fig. 22

- ▶ Remove the drawer as shown in the illustration.

Drawer on telescopic rails

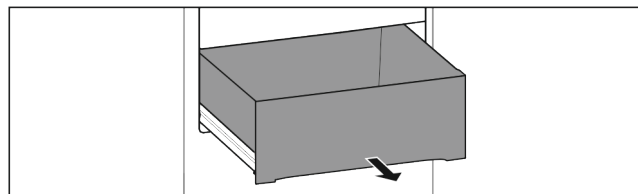

Fig. 23

Ensure that the following conditions are met:

- Drawer is completely pulled out (see Fig. 1745) .

Partial pull-out fridge compartment:

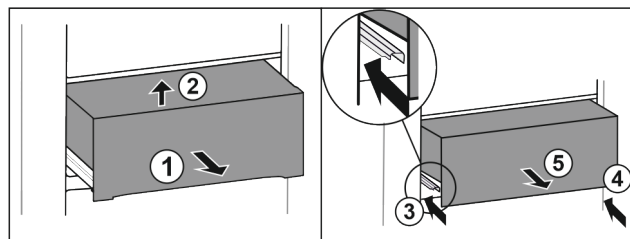

Fig. 24

- ▶ Pull out the drawer half-way Fig. 24 (1).
- ▶ Lift at the front Fig. 24 (2).
- ▶ Insert left rail Fig. 24 (3).
- ▶ Insert right rail Fig. 24 (4).
- ▶ Take out the drawer to the front Fig. 24 (5).

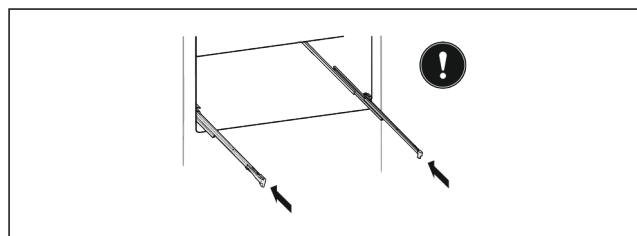

Fig. 25

If the rails are not yet fully inserted after removing the drawer:

- ▶ Push the rails in completely.

7.5.2 Inserting the drawer

Drawer on rails

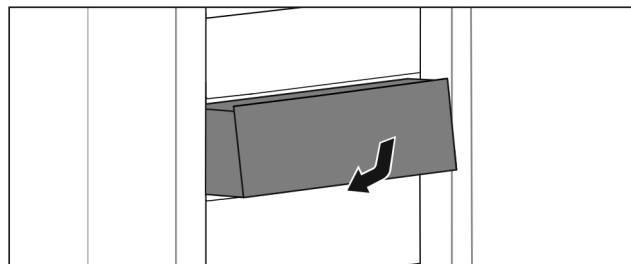

Fig. 26

- ▶ Insert the drawer as shown.

Drawer on telescopic rails

Partial pull-out fridge compartment:

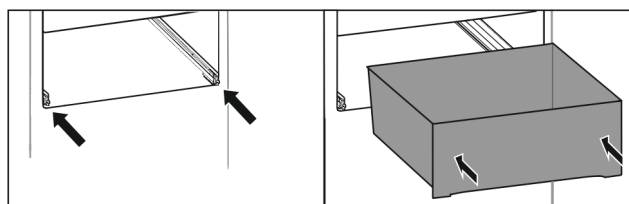

Fig. 27

- ▶ Slide the rails in.
- ▶ Place the drawer on the rails.
- ▶ Push all the way back.

7.6 Fruit & Vegetable safe cover

You can remove the compartment cover for cleaning.

7.6.1 Removing the compartment cover

Ensure that the following conditions are met:

- Bottle shelf is removed (see 7.4 Adjustable bottle shelf) .

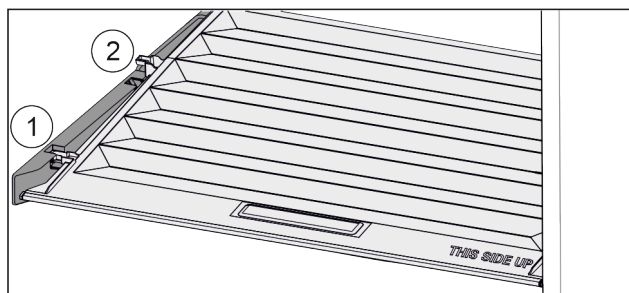

Fig. 28

When the drawers are removed:

- ▶ Pull the lid up at the front to the opening in the retaining parts Fig. 28 (1).
- ▶ Lift from the back and pull it up and out Fig. 28 (2).

Features

7.6.2 Inserting the compartment cover

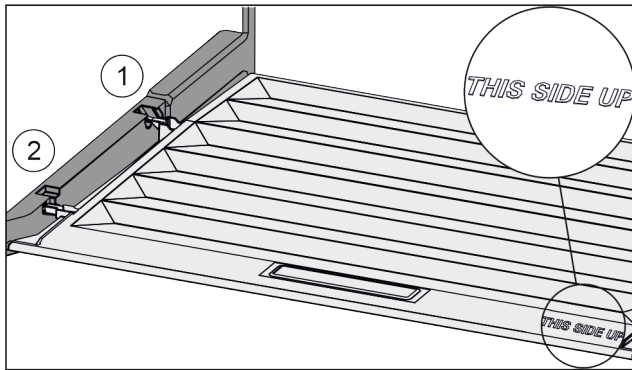

Fig. 29

If the text THIS SIDE UP points upwards:

- ▶ Insert the lip of the cover over the opening of the rear bracket Fig. 29 (1) and click into place Fig. 29 (2).
- ▶ Position the cover where you want it (see 7.7 Adjusting the moisture levels).

7.7 Adjusting the moisture levels

You can adjust the moisture in the drawer yourself by adjusting the compartment cover.

The compartment lid is attached to the drawer and can be hidden by a shelf or additional drawers.

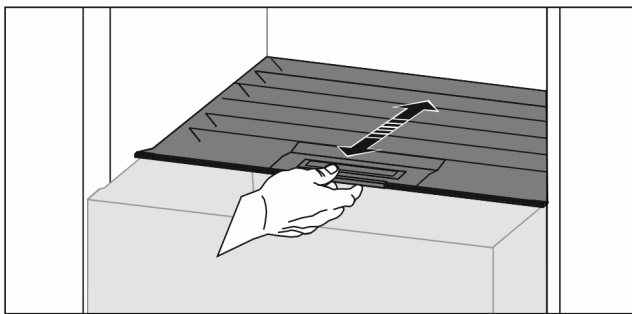

Fig. 30

Low air humidity

- ▶ Open the drawer.
- ▶ Slide the compartment cover forwards.
- ▷ With the drawer closed: Gap between the cover and the compartment.
- ▷ The air moisture in the Safe decreases.

High air moisture

- ▶ Open the drawer.
- ▶ Slide the cover back.
- ▷ With the drawer closed: The cover seals the compartment.
- ▷ The air moisture in the Safe increases.

If there is too much moisture in the compartment:

- ▶ Choose the setting "low air moisture".

-or-

- ▶ Remove any excess moisture with a cloth.

Note

You can apply the "low air moisture" setting to the Fruit & Vegetable-Safe and the Meat & Dairy-Safe.

- ▶ Set the "low air moisture" option.

7.8 EasyTwist-Ice*

The EasyTwist-Ice produces ice cubes when the water tank is inserted.

The EasyTwist-Ice is solely intended for the production of ice cubes for in standard household amounts.

Note

Do not change the position of the EasyTwist-Ice.

Ensure that the following conditions are met:

- The EasyTwist-Ice has been cleaned (see 8.3.5 Cleaning the EasyTwist-Ice*)
- The water tank has been cleaned.
- The EasyTwist-Ice drawer is fully inserted.

7.8.1 Filling the water tank



WARNING

Impure water!

Poisoning.

- ▶ Only fill with potable water.

NOTICE

Sugar-content liquids!

Damage to EasyTwist-Ice.

- ▶ Only fill with cold drinking water.

Note

Using filtered, decarbonised water ensures the best-tasting drinking water for your ice cubes.

This water quality can be achieved using a table water filter of the kind available in trade retail outlets.

- ▶ Always fill the water tank only with filtered, decarbonised drinking water.

The EasyTwist-Ice is supplied with water from the water tank.

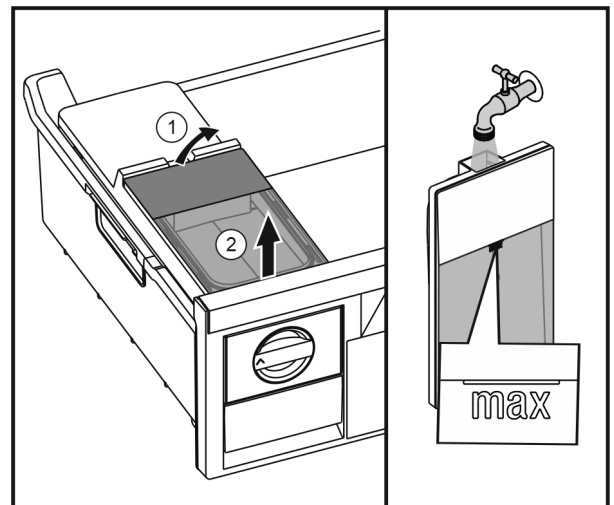

Fig. 31

- ▶ Lift up the water tank at the rear Fig. 31 (1) and remove to the top Fig. 31 (2).
- ▶ Fill with drinking water up to the marking.
- ▶ Insert the water tank by reversing the steps described above.

7.8.2 Producing ice cubes

The production volume depends on the freezer temperature. The colder the temperature, the more ice cubes that can be produced in a certain period.

Maximum capacity of the ice cube drawer – 40 cubes (2x ice cube production).

Time required for ice cube production – at least 5 hours.

Releasing the ice cubes

- ▶ Turn the knob to the right up to its stop limit.
- ▶ If necessary, repeat this step several times and turn the knob a little more.

7.9 VarioSpace

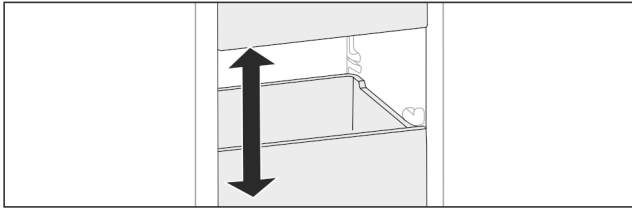

Fig. 32

You can remove drawers and glass panels from your appliance. This provides more room for large food items such as poultry, joints of meat, large game, and tall baked products. You can then freeze these items whole for later preparation.

- ▶ Note the weight limits on the drawers and glass panels (see 9.1 Technical specifications).

7.10 Accessories

7.10.1 Bottle holder

Using the bottle holder

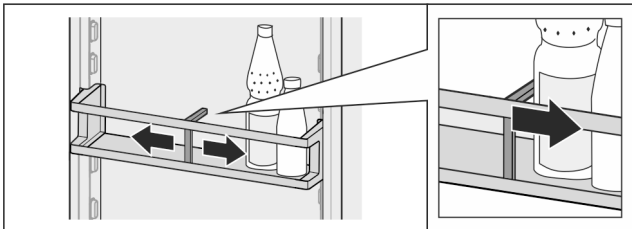

Fig. 33

- ▶ Push the bottle holder onto the bottles.
- ▷ The bottles are prevented from falling over.

Removing the bottle holder

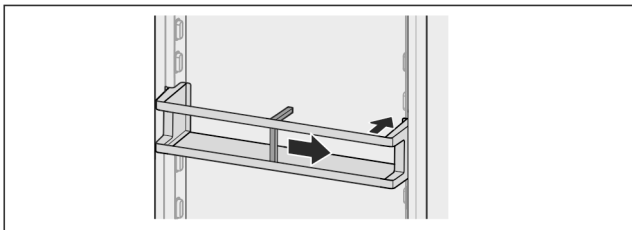

Fig. 34

- ▶ Move the bottle holder all the way to the right.
- ▶ Push the bottle holder to the back to remove.

8 Maintenance

8.1 FreshAir carbon filter

The FreshAir carbon filter is in the compartment above the fan. It guarantees the best air quality.

- Replace the carbon filter every 6 months.
With the *Reminder* setting on, a message on the display prompts you to replace it.
- The carbon filter can be disposed of with the regular household waste.

Note

You can purchase the FreshAir carbon filter from the [Liebherr household appliance store](http://home.liebherr.com) (home.liebherr.com).

8.1.1 Removing the FreshAir carbon filter

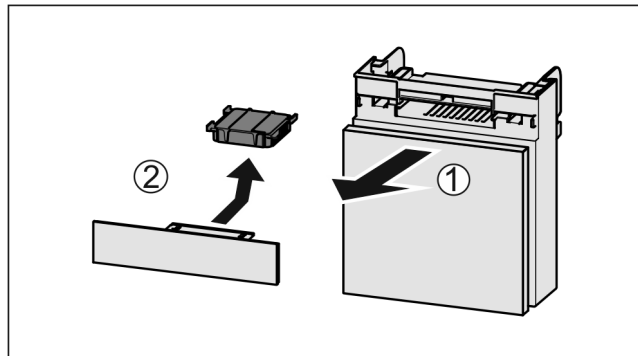

Fig. 35

- ▶ Pull out the compartment Fig. 35 (1).
- ▶ Remove the carbon filter Fig. 35 (2).

8.1.2 Inserting the FreshAir carbon filter

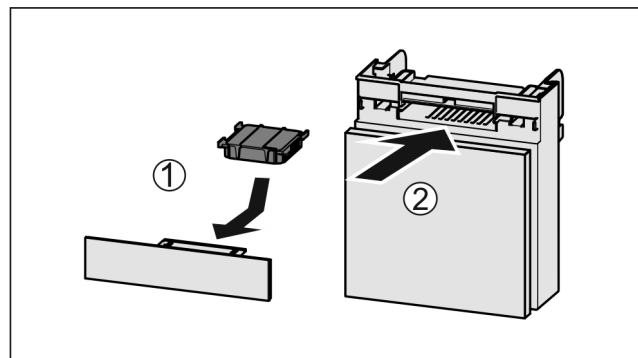

Fig. 36

- ▶ Insert the carbon filter as shown in the diagram Fig. 36 (1).
- ▷ The carbon filter clicks into place.
If the carbon filter is pointing downwards:
- ▶ Push the compartment in Fig. 36 (2).
- ▷ The carbon filter is now ready for use.

8.2 Defrosting the appliance

8.2.1 Defrosting the fridge compartment

Defrosting is performed automatically. The water from the thawing process drains through the outlet and evaporates.

- ▶ Clean the drain opening regularly (see 8.3 Cleaning the appliance).

8.2.2 Defrosting the freezer compartment with NoFrost

Defrosting is performed automatically with the NoFrost system. The moisture is deposited on the evaporator, is periodically defrosted and evaporates.

The appliance does not need to be defrosted.

8.3 Cleaning the appliance

8.3.1 Ready



WARNING

Danger of electric shock!

- ▶ Remove the refrigerator connector or interrupt the power supply.

Maintenance



WARNING

Risk of fire

▶ Do not damage the refrigeration circuit.

- ▶ Empty the appliance.
- ▶ Remove mains connector.

8.3.2 Clean the housing

NOTICE

Improper cleaning!

Damage to the appliance.

- ▶ Only use soft cleaning cloths and ph-neutral all-purpose cleaners.
- ▶ Do not use abrasive sponges or steel wool which may cause scratches.
- ▶ Do not use any sharp or abrasive cleaning agents, nor any that contain sand, chloride or acid.



WARNING

Risk of injury and damage as a result of hot steam!

Hot steam can lead to burns and can damage the surfaces.

▶ Do not use any steam cleaners!

- ▶ Wipe the housing down with soft, clean cloth. If very dirty, use lukewarm water with a neutral cleaner. Glass surfaces can also be cleaned with glass cleaner.

8.3.3 Cleaning the interior

NOTICE

Improper cleaning!

Damage to the appliance.

- ▶ Only use soft cleaning cloths and ph-neutral all-purpose cleaners.
- ▶ Do not use abrasive sponges or steel wool which may cause scratches.
- ▶ Do not use any sharp or abrasive cleaning agents, nor any that contain sand, chloride or acid.

- ▶ Plastic surfaces: clean by hand with a soft clean cloth, lukewarm water and a little detergent.
- ▶ Metal surfaces: clean by hand with a soft clean cloth, lukewarm water and a little detergent.
- ▶ Drain outlet *Fig. 1 (11)*: remove any deposits with a thin item such as a cotton bud.

8.3.4 Clean the components

NOTICE

Improper cleaning!

Damage to the appliance.

- ▶ Only use soft cleaning cloths and ph-neutral all-purpose cleaners.
- ▶ Do not use abrasive sponges or steel wool which may cause scratches.
- ▶ Do not use any sharp or abrasive cleaning agents, nor any that contain sand, chloride or acid.

Clean with a soft, clean cloth, lukewarm water and some detergent:

- Door rack
- Shelf
- Dividing shelf
- Fruit & Vegetable safe cover
- Drawer
- Adjustable bottle shelf

Clean with a damp cloth:

- Retractable rails

Please note: The grease in the tracks is used for lubrication and must not be removed!

Wash in the dishwasher up to 60 °C:

- Bottle rack
- Holder of the dividing shelf
- ▶ To disassemble components: see the relevant section.
- ▶ Clean the components.

8.3.5 Cleaning the EasyTwist-Ice*

Cleaning is required in the following cases:

- Initial operation
- Disuse for more than 48 hours
- The appliance requires cleaning.

In the case of initial operation, longer periods of disuse or the appliance requiring cleaning

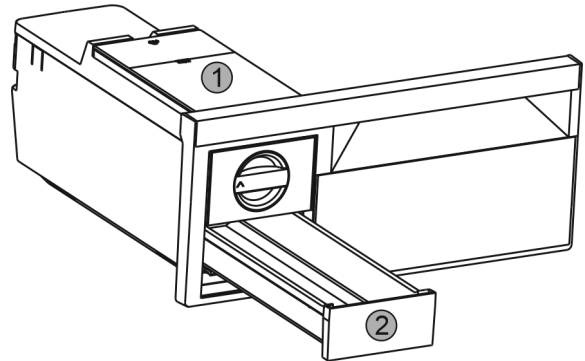

Fig. 37

- ▶ Take out the water tank *Fig. 37 (1)* and ice cube drawer *Fig. 37 (2)*.
- ▶ Take out the freezer drawer with EasyTwist-Ice.

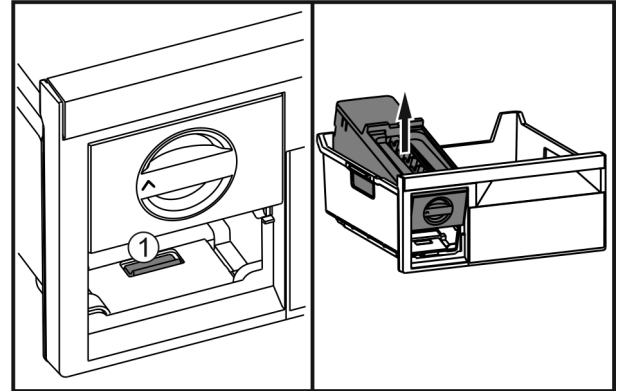

Fig. 38

- ▶ Press the lug *Fig. 38 (1)*, lift up the EasyTwist-Ice at the rear and take it out of the freezer drawer.

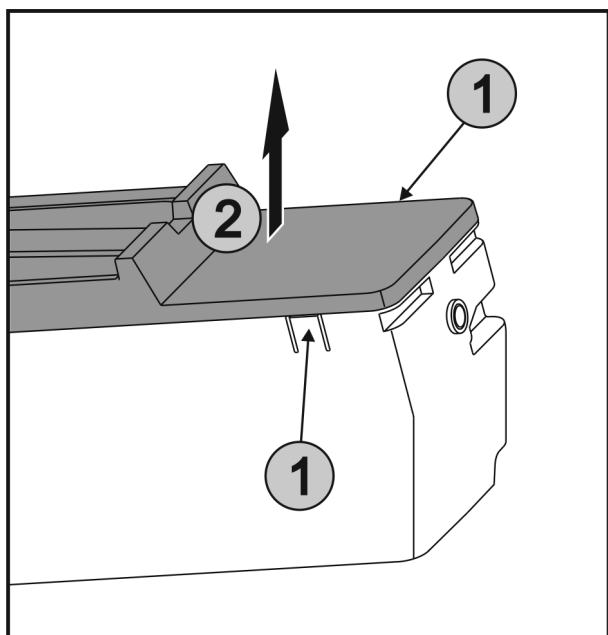

Fig. 39

- ▶ Press the lugs Fig. 39 (1) on both sides of the EasyTwist-Ice simultaneously and take off the lid Fig. 39 (2) to the top.

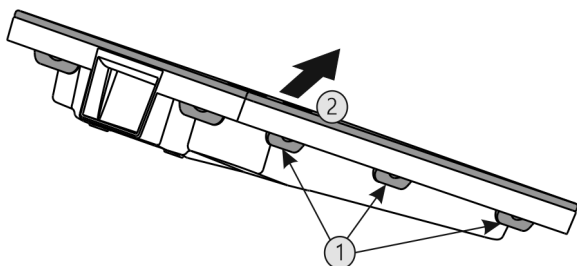

Fig. 40

- ▶ Press all lugs Fig. 40 (1) in succession and remove the lid Fig. 40 (2).
- ▶ Clean the ice cube drawer, water tank and EasyTwist-Ice with warm water and a little detergent.
- ▶ Assemble the EasyTwist-Ice.

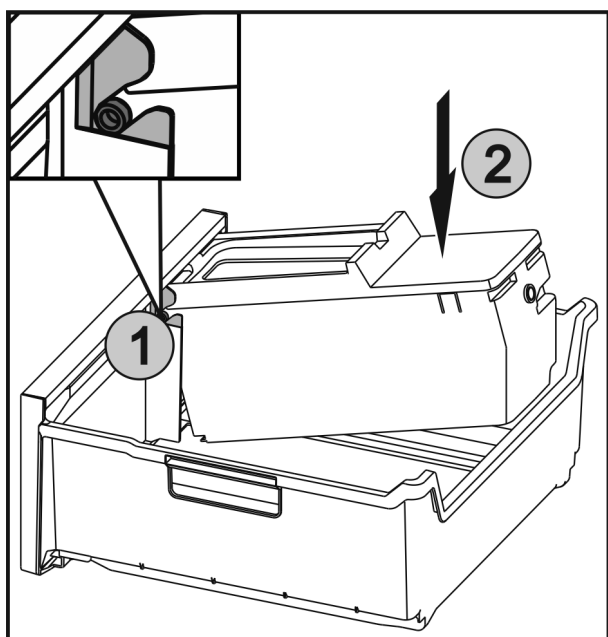

Fig. 41

- ▶ Push the axles Fig. 41 (1) on the EasyTwist-Ice into the guides and push the rear side Fig. 41 (2) until the lugs engage.

- ▶ Push in the EasyTwist-Ice drawer.

WARNING

- Impure water!
Poisoning.
- ▶ Only fill with potable water.

- ▶ Fill the water tank with water and insert it. (see 7.8.1 Filling the water tank)

With non-filtered water:

- ▶ Dispose of any ice cubes that were made within 24 hours of the first ice cubes that were produced.

With filtered water:

- ▶ Dispose of any ice cubes that were made within 48 hours of the first ice cubes that were produced.

8.3.6 After cleaning

- ▶ Wipe the appliance and the components dry.
- ▶ Connect and switch on the appliance.
- ▶ Activate SuperFrost (see 6.3 Functions) .
The temperature is cold enough:
- ▶ Place the food inside.
- ▶ Repeat cleaning regularly.

9 Customer help

9.1 Technical specifications

Temperature range	
Cooling	3 °C to 9 °C
BioFresh	0 °C to 3 °C
Freeze	-26 °C to -15 °C

Maximum freezer quantity / 24 hrs		
Freezer compartment		See the type plate under "Freezer goods ... /24 hours"

Maximum component capacity			
Features	Appliance width 55 cm (see Installation Guide, Appliance Dimensions)	Appliance width 60 cm (see Installation Guide, Appliance Dimensions)	Appliance width 70 cm (see Installation Guide, Appliance Dimensions)
Drawer	12 kg	12 kg	
Freezer compartment			
Glass shelf in the freezer section	35 kg	35 kg	55 kg

Lighting	
Class ¹	Light source
This product contains a light source that meets energy efficiency rating G	LED

¹ The appliance may contain light sources with different energy efficiency classes. The lowest energy efficiency class is indicated.

For appliances with a WiFi connection:*

Frequency specification*	
Frequency band	2.4 GHz
Maximum radiated power	<100 mW
Purpose of the wireless equipment	Integration in the local WiFi network for data communication

9.2 Operating noises

The appliance makes different noises when it is on.

- At **higher temperatures** the appliance uses less energy but works for longer. It is **quieter**.
- At **lower temperatures** the food is cooled faster. It is **louder**.

Examples:

- Functions on (see 6.3 Functions)
- Fan running
- Food recently added
- High ambient temperature
- Door open for a while

Noise	Possible cause	Type of noise
Bubbling and splashing	Coolant flowing into the cooling circuit.	Normal operating noise
Hissing	Coolant sprays into the cooling circuit.	Normal operating noise
Humming	The appliance is cooling. The volume depends on the cooling output.	Normal operating noise

Noise	Possible cause	Type of noise
Humming and rustling	The fan is running.	Normal operating noise
Clicking	Components are switched on and off.	Normal switching noise
Rattling humming or	Valves or flaps are working.	Normal switching noise

Noise	Possible cause	Type of noise	Lifting
Vibration	Improper setup	Defective noise	Level the appliance using the adjustable feet.
Rattling	Components, items inside the appliance	Defective noise	Secure components. Leave enough space between the items.

9.3 Technical fault

Your appliance is designed and built to ensure it works reliably and has a long service life. In the unlikely event that a fault occurs during operation, please check whether it is due to an operating error. If so, you will be charged for the callout and repair costs even if it falls within the warranty period.

You can fix the following faults yourself.

9.3.1 Appliance function

Defect	Cause	Remedy
The appliance is not working.	→ The appliance is not switched on.	▶ Switch the appliance on.
	→ The power plug is not properly plugged into the socket.	▶ Check the power plug.
	→ There is something wrong with the power outlet fuse.	▶ Check the fuse.
	→ Power cut	▶ Keep the appliance closed. ▶ Protecting food: Lay freezer packs on top of the food or use another freezer if the power is off for a prolonged period. ▶ Do not re-freeze defrosted food,
	→ The appliance plug does not fit the appliance properly.	▶ Check the appliance plug.
Temperature is not cold enough.	→ The appliance door is not closed properly.	▶ Close the appliance door.
	→ Not enough ventilation.	▶ Keep ventilation grille clear, and clean it.
	→ The ambient temperature is too high.	▶ Solution: (see 1.3 Appliance range of use) .
	→ The appliance was opened too many times or for too long.	▶ Wait to see if the required temperature corrects itself. If not, contact Customer Service (see 9.4 Customer Services) .
	→ Too much fresh food was placed inside without SuperFrost.	▶ Solution: (see SuperFrost)
	→ The temperature is set incorrectly.	▶ Turn down the temperature and check after 24 hours.
	→ The appliance is too close to a heat source (oven, radiator, etc).	▶ Move the appliance or the heat source.

Defect	Cause	Remedy
The status display does not light up.	→ The status display is switched off.	▶ Turn on the status display .
	→ The door is open.	▶ Close the door.
	→ The appliance is switched off.	▶ Switch the appliance on.
	→ LED is faulty.	▶ Contact Customer Services (see 8 Maintenance) .
The door seal is defective or needs to be replaced for another reason.	→ The door seal can be replaced. It can be replaced without the need for special tools.	▶ Contact Customer Services (see 9.4 Customer Services) .
The appliance builds up too much ice or condensation.	→ The door seal may have slipped out of its groove.	▶ Check that the door seal is well fitted in the groove.
The appliance is hot to touch on the outside*.	→ The heat of the refrigeration circuit is used to avoid condensation.	▶ This is normal.

9.3.2 Features

Defect	Cause	Remedy
The internal light does not come on.	→ The appliance is not switched on.	▶ Switch the appliance on.
	→ The door was open for longer than 15 minutes.	▶ Interior lighting turns off automatically after approx. 15 min. with the door open.
	→ The LED light is faulty or the cover is damaged:	 WARNING Risk of injury due to electric shock! There are live electrical parts under the cover. ▶ Only ever have the inside LED light replaced or repaired by customer service or trained personnel.

9.4 Customer Services

First check if you can fix the error yourself (see 9 Customer help) . If you can't, contact Customer Services.

Please refer to the enclosed "Liebherr-Service" brochure for the address.



WARNING

Unprofessional repair!
Injuries.

- ▶ Have any repairs and action - not expressly specified - on the appliance and mains cable carried out by service personnel only. (see 8 Maintenance)
- ▶ A damaged mains cable may only be replaced by the manufacturer, the manufacturer's Customer Service or a similarly qualified person.
- ▶ In the case of appliances with an IEC connector, the change may be made by the customer.

9.4.1 Contact Customer Services

Make sure you have the following appliance data at the ready:

- Appliance name (model and index)
- Service no. (Service)
- Serial no. (S no.)
- ▶ Look up the appliance information on the display (see Info) .

-or-

- ▶ Referring to appliance info on the nameplate (see 9.5 Model plate) .
- ▶ Note down the appliance information.
- ▶ Notify Customer Services of the following: Give us the appliance data.
- ▷ This will help us to provide you with a faster, more accurate service.
- ▶ Follow any further instructions given by Customer Services.

9.5 Model plate

The model plate is behind the drawers on the inside of the appliance.

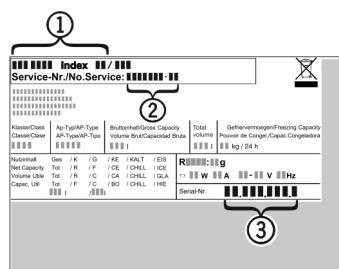

Fig. 42

- (1) Appliance description
- (2) Service no.
- (3) Serial no.
- ▶ Note the data on the model plate.

Shutting down

10 Shutting down

- ▶ Empty the appliance.
- ▶ Turn off the appliance (see 6.4 Settings).
- ▶ Remove mains connector.
- ▶ Remove appliance connector if required: Remove and move from left to right at the same time.
- ▶ Clean the appliance (see 8.3 Cleaning the appliance).
- ▶ Leave the door open to avoid bad smells building up.

- ▶ Dispose of batteries, lamps and the appliance according to the above specifications.

11 Disposal

Preparing appliance for disposal



Li-Ion

Liebherr uses batteries in some of its appliances. In the EU, for environmental reasons, legislation obliges the end user to remove these batteries before disposing of old appliances. If your appliance contains batteries, a corresponding notice is attached.

Lamps If you can remove the lamps yourself without destroying them, also remove these before disposal.

- ▶ Take the appliance out of operation.
- ▶ Appliances with batteries: remove the batteries. For description, see **Maintenance** chapter.
- ▶ If possible: remove lamps without destroying them.

Disposing of the appliance in an environmentally friendly manner



The appliance still contains valuable materials and must be disposed of separately from unsorted municipal waste.



Li-Ion



Li-Ion

Dispose of batteries separately from the old appliance. To do this, you can return the batteries free of charge to retailers as well as recycling centres and collection centres for recyclable materials.

Lamps Dispose of removed lamps via the respective collection systems.

For Germany: You can dispose of the appliance free of charge via the class 1 collection containers at the local recycling and recyclable material collection centres. When purchasing a new fridge/freezer, if the sales area > 400 m², retailers will also take back the old appliance free of charge.



WARNING

Leaking coolant and oil!

Fire. The coolant contained in the appliance is eco-friendly, but also flammable. The oil contained in the appliance is flammable. Escaping coolant and oil can ignite if the concentration is high enough and in contact with an external heat source.

- ▶ Do not damage the pipelines of the coolant circuit and the compressor.

- ▶ Transport the appliance without damaging it.



home.liebherr.com/fridge-manuals

EN fridge/freezer with BioFresh

Issue date: 20220309

Part number index: 7080438-00

Liebherr-Hausgeräte Marica EOOD
Bezirk Plovdiv
4202 Radinovo
Bulgarien