

LUT5NE28W2

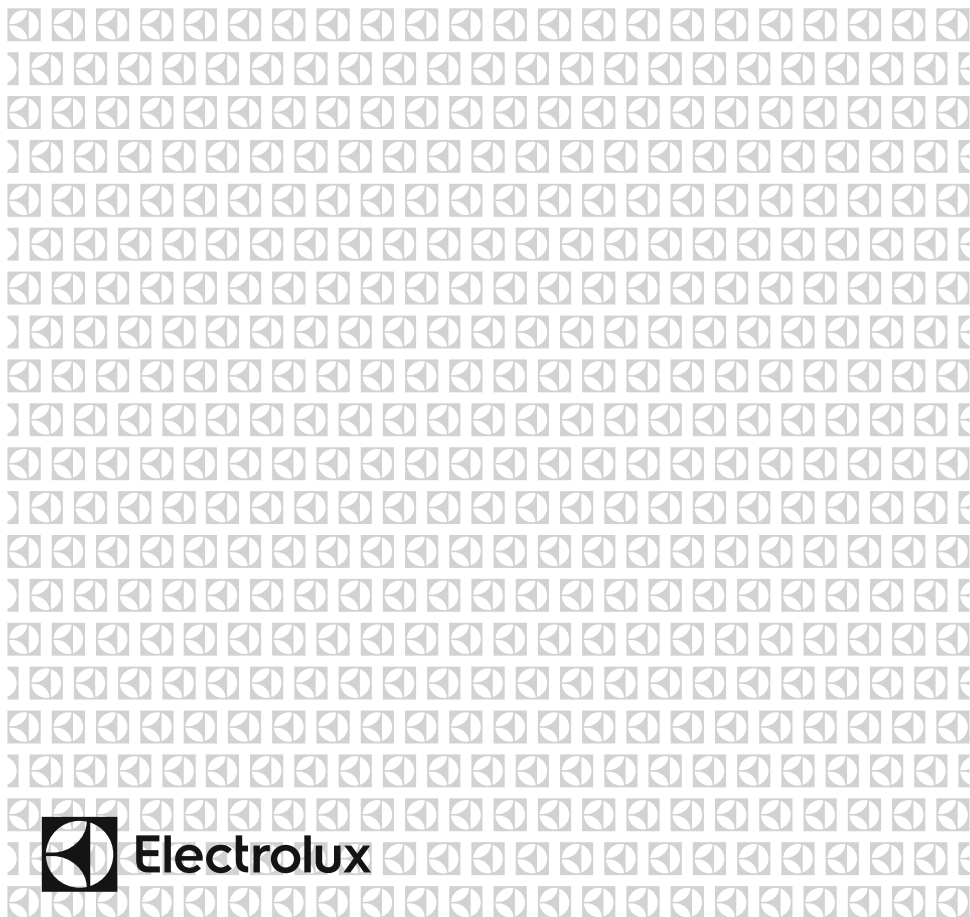

EN FREEZER

User Manual





EN

FIRE

Warning; Risk of fire / flammable materials

CONTENTS

BEFORE USING THE APPLIANCE	5
General warnings	5
Old and out-of-order fridges or freezer	9
Safety warnings	9
Installation warnings	10
Before using your freezer	11
Dimensions	12
THE VARIOUS FUNCTION AND POSSIBILITIES	13
Information on No-Frost technology	13
Display and Control Panel	14
Operating your Freezer	14
Super Freezer Mode	14
Freezer Temperature Settings	14
Warnings about temperature adjustments	15
Accessories	16
Ice Tray	16
The Icematic	16
ARRANGING FOOD IN THE APPLIANCE	16
CLEANING AND MAINTENANCE	20
Defrosting	20
TRANSPORTATION AND CHANGING OF INSTALLATION POSITION	21
Repositioning the Door	21
BEFORE CALLING YOUR AFTER SALES SERVICE.....	22
Hints for Energy Saving.....	23
THE PARTS OF THE APPLIANCE AND THE COMPARTMENTS	24
TECHNICAL DATA	25
INFORMATION FOR TEST INSTITUTES.....	25

WE'RE THINKING OF YOU

Thank you for purchasing an Electrolux appliance. You've chosen a product that brings with it decades of professional experience and innovation. Ingenious and stylish, it has been designed with you in mind. So whenever you use it, you can be safe in the knowledge that you'll get great results every time.

Welcome to Electrolux.

Visit our website to:



Get usage advice, brochures, trouble shooter, service and repair information:
www.electrolux.com/support



Register your product for better service:
www.registerelectrolux.com



Buy Accessories, Consumables and Original spare parts for your appliance:
www.electrolux.com/shop

CUSTOMER CARE AND SERVICE

Always use original spare parts.

When contacting our Authorised Service Centre, ensure that you have the following data available: Model, PNC, Serial Number.

The information can be found on the rating plate.

 Warning / Caution-Safety information

 General information and tips

 Environmental information

Subject to change without notice.

PART - 1. BEFORE USING THE APPLIANCE

General warnings

Please read the instruction manual carefully before installing and using your appliance. We are not responsible for the damage occurred due to misuse.

Follow all instructions on your appliance and instruction manual, and keep this manual in a safe place to resolve the problems that may occur in the future.

This appliance is not intended to be used as a built-in appliance. In case of different installation from freestanding respecting space required in use dimensions, the appliance will function correctly but energy consumption might increase slightly.

⚠ WARNING: Keep ventilation openings, in the appliance enclosure or in the built-in structure, clear of obstruction.

⚠ WARNING: Do not use mechanical devices or other means to accelerate the defrosting process, other than those recommended by the manufacturer.

⚠ WARNING: Do not use electrical appliances inside the food storage compartments of the appliance, unless they are of the type recommended by the manufacturer.

⚠ WARNING: Do not damage the refrigerant circuit.

⚠ WARNING: When positioning the appliance, ensure the supply cord is not trapped or damaged.

⚠ WARNING: Do not locate multiple portable socket-outlets or portable power supplies at the rear of the appliance.

⚠ WARNING: In order to avoid any hazards resulting from the instability of the appliance, it must be fixed in accordance with the following instructions:

 If your appliance uses R600a as a refrigerant (this information will be provided on the label of the cooler) you should take care during transportation and installation to prevent the cooler elements from being damaged. R600a is an environmentally friendly and natural gas, but it is explosive. In the event of a leak due to damage of the cooler elements, move your fridge away from open flames or heat sources and ventilate the room where the appliance is located for a few minutes.

- Keep all packaging away from children and dispose of it appropriately.
- While carrying and positioning the fridge, do not damage the cooler gas circuit.
- Do not store explosive substances such as aerosol cans with a flammable propellant in this appliance.
- This appliance is for storing food and beverages only.
- This appliance is designed for single household domestic use in an indoor environment.
- This appliance may be used in offices, hotel guest rooms, bed & breakfast guest rooms, farm guest houses and other similar accommodation where such use does not exceed (average) domestic usage levels.
- If the socket does not match the refrigerator plug, it must be replaced by the manufacturer, a service agent or similarly qualified persons in order to avoid a hazard.
- A specially grounded plug has been connected to the power cable of your refrigerator. This plug should be used with a specially grounded socket of 16 amperes or 10 amperes according to country where the product will be sold. If there is no such socket in your house, please have it installed by an authorized electrician.

- This appliance can be used by children aged from 8 years and above and persons with reduced physical, sensory or mental capabilities or lack of experience and knowledge if they have been given supervision or instruction concerning use of the appliance in a safe way and understand the hazards involved. Children shall not play with the appliance. Cleaning and user maintenance shall not be made by children without supervision.
- Children aged from 3 to 8 years are allowed to load and unload refrigerating appliances. Children are not expected to perform cleaning or user maintenance of the appliance, very young children (0-3 years old) are not expected to use appliances, young children (3-8 years old) are not expected to use appliances safely unless continuous supervision is given, older children (8-14 years old) and vulnerable people can use appliances safely after they have been given appropriate supervision or instruction concerning use of the appliance. Very vulnerable people are not expected to use appliances safely unless continuous supervision is given.
- If the supply cord is damaged, it must be replaced by the manufacturer, an authorised service agent or similar qualified persons, in order to avoid a hazard.
- This appliance is not intended for use at altitudes exceeding 2000 m.

To avoid contamination of food, please respect the following instructions:

- Opening the door for long periods can cause a significant increase of the temperature in the compartments of the appliance.
- Clean regularly surfaces that can come in contact with food and accessible drainage systems
- Store raw meat and fish in suitable containers in the refrigerator, so that it is not in contact with or drip onto other food.

- Two-star frozen-food compartments are suitable for storing pre-frozen food, storing or making ice cream and making ice cubes.
- One-, two- and three-star compartments are not suitable for the freezing of fresh food.
- If the refrigerating appliance is left empty for long periods, switch off, defrost, clean, dry, and leave the door open to prevent mould developing within the appliance.

Service

- To repair the appliance contact the Authorised Service Centre. Use original spare parts only.
- Please note that self-repair or nonprofessional repair can have safety consequences and might void the guarantee.
- The following spare parts will be available for 7 years after the model has been discontinued: thermostats, temperature sensors, printed circuit boards, light sources, door handles, door hinges, trays and baskets.
- Please note that some of these spare parts are only available to professional repairers, and that not all spare parts are relevant for all models.
- Door gaskets will be available for 10 years after the model has been discontinued.

Old and out-of-order fridges or freezer

- If your old fridge or freezer has a lock, break or remove the lock before discarding it, because children may get trapped inside it and may cause an accident.
- Old fridges and freezers contain isolation material and refrigerant with CFC. Therefore, take care not to harm environment when you are discarding your old fridges.

Disposal of your old appliance



The symbol on the product or on its packaging indicates that this product may not be treated as household waste. Instead it shall be handed over to the applicable collection point for the recycling of electrical and electronic equipment. By ensuring this product is disposed of correctly, you will help prevent potential negative consequences for the environment and human health, which could otherwise be caused by inappropriate waste handling of this product. For more

detailed information about recycling of this product, please contact your local city office, your household waste disposal service or the shop where you purchased the product.

Notes:

- Please read the instruction manual carefully before installing and using your appliance. We are not responsible for the damage occurred due to misuse.
- Follow all instructions on your appliance and instruction manual, and keep this manual in a safe place to resolve the problems that may occur in the future.
- This appliance is produced to be used in homes and it can only be used in domestic environments and for the specified purposes. It is not suitable for commercial or common use. Such use will cause the guarantee of the appliance to be cancelled and our company will not be responsible for any losses incurred.
- This appliance is produced to be used in houses and it is only suitable for cooling / storing foods. It is not suitable for commercial or common use and/or for storing substances except for food. Our company is not responsible for any losses incurred by inappropriate usage of the appliance.

Safety warnings

- Do not connect your freezer to the mains electricity supply using an extension lead.
- Do not use damaged, torn or old plugs.
- Do not pull, bend or damage the cord.

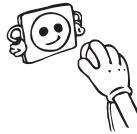

- Do not use plug adapter.
- This appliance is designed for use by adults. Do not allow children to play with the appliance or hang off the door.
- Never touch the power cord/plug with wet hands. This may cause a short circuit or electric shock.



- Do not place glass bottles or cans in the ice-making compartment as they will burst when the contents freeze.
- Do not place explosive or flammable material in your freezer.
- When removing ice from the ice-making compartment, do not touch it. Ice may cause frost burns and/or cuts.
- Do not touch frozen goods with wet hands. Do not eat ice-cream or ice cubes immediately after they are removed from the ice-making compartment.
- Do not re-freeze thawed frozen food. This may cause health issues such as food poisoning.



When the door of the freezer is closed, a vacuum seal will form. Wait for 1 minute before reopening it. This application is optional for easy opening of the door. With this application, a little condensation may occur around this area and you may remove it.

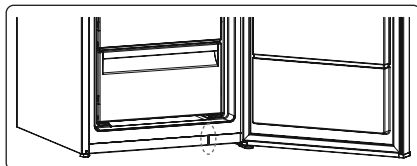

Installation warnings

Before using your freezer for the first time, please pay attention to the following points:

- The operating voltage for your freezer is 220-240 V at 50Hz.
- The plug must be accessible after installation.
- Your freezer may have an odour when it is operated for the first time. This is normal and the odour will fade when your freezer starts to cool.
- Before connecting your freezer, ensure that the information on the data plate (voltage and connected load) matches that of the mains electricity supply. If in doubt, consult a qualified electrician.
- Insert the plug into a socket with an efficient ground connection. If the socket has no ground contact or the plug does not match, we recommend you consult a qualified electrician for assistance.
- The appliance must be connected with a properly installed fused socket. The power supply (AC) and voltage at the operating point must match with the details on the name plate of the appliance (the name plate is located on the inside left of the appliance).
- We do not accept responsibility for any damages that occur due to ungrounded usage.
- Place your freezer where it will not be exposed to direct sunlight.
- Your freezer must never be used outdoors or exposed to rain.
- Your appliance must be at least 50 cm away from stoves, gas ovens and heater cores, and at least 5 cm away from electrical ovens.
- Do not cover the body or top of freezer with lace. This will affect the performance of your freezer.
- Top clearance required for the appliance can be derived from dimensions provided in chapter Dimensions.
- Do not place heavy items on the appliance.
- Clean the appliance thoroughly before use (see Cleaning and Maintenance).
- Before using your freezer, wipe all parts with a solution of warm water and a teaspoon of sodium bicarbonate. Then, rinse with clean water and dry. Return all parts to the freezer after cleaning.



- Use the adjustable front legs to make sure your appliance is level and stable. You can adjust the legs by turning them in either direction. This must be done before placing food in the appliance.
- Install the two plastic distance guides (the parts on the black vanes -condenser- at the rear) by turning it 90° (as shown in the figure) to prevent the condenser from touching the wall.
- If you position the appliance against a wall in a freestanding installation, install the rear spacers in order to guarantee the maximum possible distance
- For Side by Side niche installation please refer to the Joining Kit provided with the cabinet freezer and its installation manual (NOTE: joining kit is also available separately as accessory).

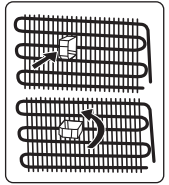

Before using your freezer

- When using your freezer for the first time, or after transportation, keep it in an upright position for at least 3 hours before plugging into the mains. This allows efficient operation and prevents damage to the compressor.
- Your freezer may have a smell when it is operated for the first time. This is normal and the smell will fade away when your freezer starts to cool.



Internal lighting

 **WARNING!**
Risk of electric shock.

- Concerning the lamp(s) inside this product and spare part lamps sold separately: These lamps are intended to withstand extreme physical conditions in household appliances, such as temperature, vibration, humidity, or are intended to signal information about the operational status of the appliance. They are not intended to be used in other applications and are not suitable for household room illumination.

Dimensions

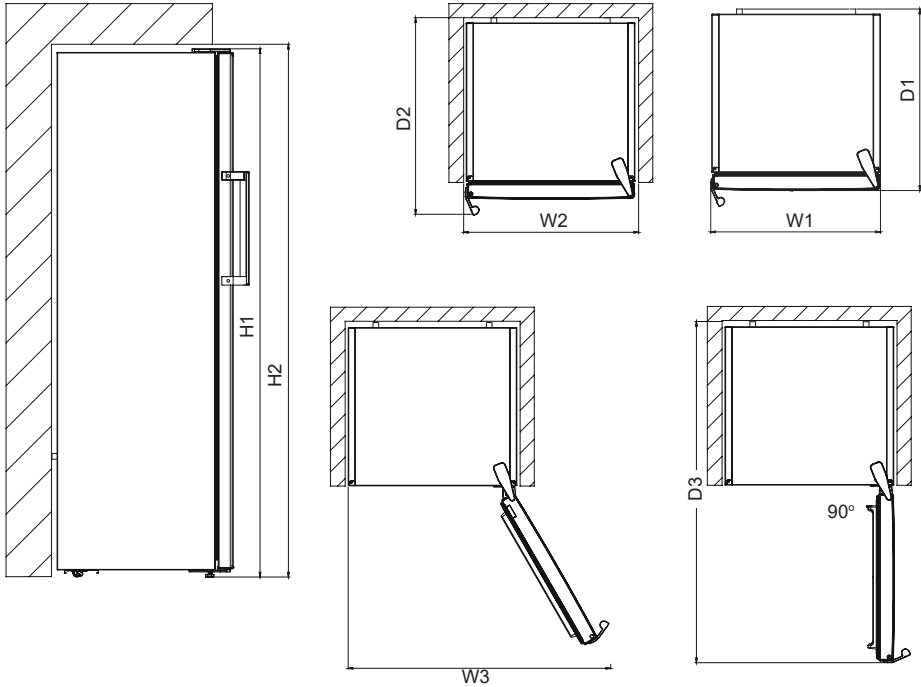

Overall dimensions ¹		
H1*	mm	1860
W1	mm	595
D1	mm	650

¹ the height, width and depth of the appliance without the handle

* including the height of the top hinge (10 mm)

Space required in use ²		
H2	mm	1900
W2	mm	600
D2	mm	718

² the height, width and depth of the appliance including the handle, plus the space necessary for free circulation of the cooling air

Overall space required in use ³		
W3	mm	649
D3	mm	1224

³ the height, width and depth of the appliance including the handle, plus the space necessary for free circulation of the cooling air, plus the space necessary to allow door opening to the minimum angle permitting removal of all internal equipment

PART - 2. THE VARIOUS FUNCTION AND POSSIBILITIES

Information on No-Frost technology

No-frost freezers differ from other static freezers in their operating principle.

In normal freezers, the humidity entering the freezer due to opening the door and the humidity inherent in the food causes freezing in the freezer compartment. To defrost the frost and ice in the freezer compartment, you are periodically required to turn off the freezer, place the food that needs to be kept frozen in a separately cooled container and remove the ice gathered in the freezer compartment.

The situation is completely different in no-frost freezers. Dry and cold air is blown into the freezer compartment homogeneously and evenly from several points via a blower fan. Cold air dispersed homogeneously and evenly between the shelves cools all of your food equally and uniformly, thus preventing humidity and freezing.

Therefore your no-frost freezer allows you ease of use, in addition to its huge capacity and stylish appearance.

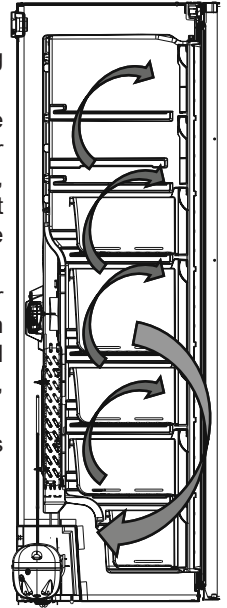

Display and Control Panel

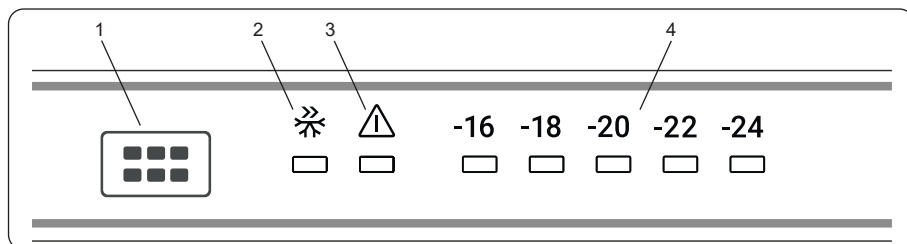

Using the Control Panel

1. Freezer temperature set button
2. Super freeze symbol (Super freeze LED)
3. Alarm symbol (Alarm LED)
4. Freezer adjusted temperature indicator

Operating your Freezer

Lighting (If available)

When the product is plugged in for the first time, the interior lights may turn on 1 minute late due to opening tests.

Alarm light

In case of a problem within the freezer, the alarm led will release red light.

Freezer Temperature Set Button

This button allows setting temperature of the freezer. In order to set values for freezer partition, press this button. Use this button also to activate super freeze mode.

Super Freezer Mode

When Would It Be Used?

- To freeze huge quantities of food.
- To freeze fast food.
- To freeze food quickly.
- To store seasonal food for a long time.

How To Use?

- Press temperature set button until super freezing light comes on.
- Super freezing led will light during this mode.
- Maximum amount of fresh food (in kilograms) to be frozen within 24 hours is shown on the appliance label.
- For optimal appliance performance in maximum freezer capacity, set the appliance to active super freeze mode 24 hours before you put the fresh food into the freezer.

During This Mode:

If you press temperature set button, the mode will be cancelled and the setting will be restored from -16.

Freezer Temperature Settings

- The initial temperature of the setting display is -18 °C.

- Press freezer setting button once.
- Every time you press the button, the setting temperature will decrease. (-16 °C, -18 °C, -20 °C,.. super freezing)
- If you press freezer setting button until super freezer symbol is displayed on freezer.
- Settings display and you do not press any button within the following 3 seconds, super freezing will blink.
- If you keep on pressing, it will restart from last value.

Recommended Temperature Values for Freezer

When to adjust	Inner Temperature
For minimum freezing capacity	-16 °C
In normal usage	-18 °C
For maximum freezing capacity	-22 °C, -24 °C

Warnings about temperature adjustments

- It is not recommended that you operate your freezer in environments colder than 10°C in terms of its efficiency.
- Do not start another adjustment while you are already making an adjustment.
- Temperature adjustments should be made according to the frequency of door openings, the quantity of food kept inside the freezer and the ambient temperature in the location of your freezer.
- In order to allow your freezer to reach the operating temperature after being connected to mains, do not open the door frequently or place large quantities of food in the freezer. Please note that, depending on the ambient temperature, it may take 24 hours for your freezer to reach the operating temperature.
- A 5 minute delay function is applied to prevent damage to the compressor of your freezer when connecting or disconnecting to mains, or when an energy breakdown occurs. Your freezer will begin to operate normally after 5 minutes.
- Your appliance is designed to operate in the ambient temperature (T/SN = 10°C - 43°C) intervals stated in the standards, according to the climate class displayed on the information label. We do not recommend operating your appliance out of the stated temperature limits in terms of cooling effectiveness.

Climate class	Meaning	Ambient Temperature
T	Tropical	This refrigerating appliance is intended to be used at ambient temperatures ranging from 16 °C to 43 °C.
ST	Subtropical	This refrigerating appliance is intended to be used at ambient temperatures ranging from 16 °C to 38 °C.
N	Temperate	This refrigerating appliance is intended to be used at ambient temperatures ranging from 16 °C to 32 °C.
SN	Extended temperate	This refrigerating appliance is intended to be used at ambient temperatures ranging from 10 °C to 32 °C.

This appliance is intended to be used at ambient temperature ranging from 10°C to 43°C. The correct operation of the appliance can only be guaranteed within the specified temperature range.

Accessories

Ice Tray (In some models)

- Fill the ice tray with water and place in the freezer compartment.
- After the water has completely frozen, you can twist the tray as shown below to remove the ice cubes.

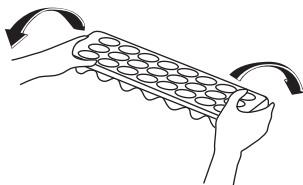
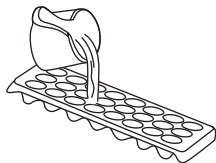

The Icematic (In some models)

- Pull the lever towards you and remove the ice maker tray
- Fill with water to the marked level
- Hold the left end of the lever and set the ice-tray on the icebox
- When ice cubes have formed, twist the lever to drop the ice cubes into the icebox.

 **Do not fill the icebox with water in order to make ice. It will break.**

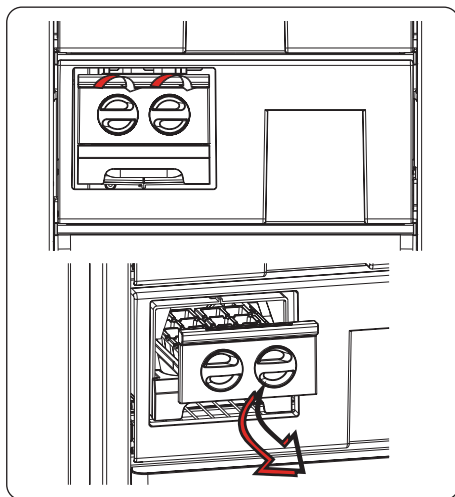

Visual and text descriptions in the accessories section may vary according to the model of your appliance.

PART - 3. ARRANGING FOOD IN THE APPLIANCE

- Freezer compartment is the one marked with  ***.
- The freezer is used for storing frozen food, freezing fresh food, and making ice cubes.
- For freezing fresh food; wrap and seal fresh food properly, that is the packaging should be air tight and shouldn't leak. Special freezer bags, aluminum foil polythene bags and plastic containers are ideal.
- Do not store fresh food next to frozen food as it can thaw the frozen food.
- Before freezing fresh food, divide it into portions that can be consumed in one sitting.
- Consume thawed frozen food within a short period of time after defrosting
- Never place warm food in the freezer compartment as it will thaw the frozen food.
- Always follow the manufacturer's instructions on food packaging when storing frozen

food. If no information is provided food, should not be stored for more than 3 months from the date of purchase.

- When purchasing frozen food, make sure that it has been stored under appropriate conditions and that the packaging is not damaged.
- Frozen food should be transported in appropriate containers and placed in the freezer as soon as possible.
- Do not purchase frozen food if the packaging shows signs of humidity and abnormal swelling. It is probable that it has been stored at an unsuitable temperature and that the contents have deteriorated.
- The storage life of frozen food depends on the room temperature, the thermostat setting, how often the door is opened, the type of food, and the length of time required to transport the product from the shop to your home. Always follow the instructions printed on the packaging and never exceed the maximum storage life indicated.
- The maximum amount of fresh food (in kg) that can be frozen in 24 hours is indicated on the appliance label.
- Use the fast freezing shelf to freeze home cooking (and any other food which needs to be frozen quickly) more quickly because of the freezing shelf's greater freezing power. Fast freezing shelf is the bottom drawer of the freezer compartment.

If you would use maximum freezing capacity of your freezer:

- While freezing fresh foods, the maximum amount of fresh food (in kg) that can be frozen in 24 hours is indicated on the appliance label.
- For optimum appliance performance to reach maximum freezing capacity, activate Super Freeze (SF) mode 24 hours before placing fresh food into the freezer.
- After placing fresh food into the freezer, 24 hours is generally sufficient for freezing. "Super Freeze" mode will be deactivated automatically in 2-3 days to save energy.

If you would freeze a small amount (up to 3 kg) in your freezer:

- Place your food without touching already frozen food and activate "Fast Freezing" mode. You can put your food next to other frozen food after it is completely frozen (after minimum 24 hours).
- Do not re-freeze frozen food after it has thawed. This may cause health issues, such as food poisoning.
- Allow hot food to completely cool down before placing it in the freezer.
- When buying frozen food ensure that these have been frozen at suitable temperatures and that the packing is intact.

NOTE: If you attempt to open the freezer door immediately after closing it, you will find that it will not open easily. This is normal. Once equilibrium has been reached, the door will open easily.

Important note:

- Never refreeze thawed frozen food.
- The taste of some spices found in cooked dishes (anise, basilica, watercress, vinegar, assorted spices, ginger, garlic, onion, mustard, thyme, marjoram, black pepper, etc.) changes and they assume a strong taste when they are stored for a long period of time. Therefore, add small amounts of spices to food to be frozen, or the desired spice should be added after the food has thawed.

- The storage time of food is dependent on the type of oil used. Suitable oils are margarine, calf fat, olive oil and butter. Unsuitable oils are peanut oil and pig fat.
- Food in liquid form should be frozen in plastic cups and other food should be frozen in plastic folios or bags.



The table below is a quick guide to show you the most efficient way to store the major food groups in your freezer compartment.

Meat and fish	Preparation	Maximum storage time (months)
Steak	Wrap in foil	6 - 8
Lamb meat	Wrap in foil	6 - 8
Veal roast	Wrap in foil	6 - 8
Veal cubes	In small pieces	6 - 8
Lamb cubes	In pieces	4 - 8
Minced meat	In packaging without using spices	1 - 3
Giblets (pieces)	In pieces	1 - 3
Bologna sausage/salami	Should be kept packaged even if it has a membrane	1 - 3
Chicken and turkey	Wrap in foil	4 - 6
Goose and duck	Wrap in foil	4 - 6
Deer, rabbit, wild boar	In 2.5 kg portions or as fillets	6 - 8
Freshwater fish (Salmon, Carp, Crane, Catfish)	After cleaning the bowels and scales of the fish, wash and dry it. If necessary, remove the tail and head.	2
Lean fish (Bass, Turbot, Flounder)		4
Fatty fishes (Tuna, Mackerel, Bluefish, Anchovy)		2 - 4
Shellfish	Clean and in a bag	4 - 6
Caviar	In its packaging, or in an aluminium or plastic container	2 - 3
Snails	In salty water, or in an aluminium or plastic container	3



NOTE: Thawed frozen meat should be cooked as fresh meat. If the meat is not cooked after defrosting, it must not be re-frozen.

Vegetables and Fruits	Preparation	Maximum storage time (months)
String beans and beans	Wash, cut into small pieces and boil in water	10 - 13
Beans	Hull, wash and boil in water	12
Cabbage	Clean and boil in water	6 - 8
Carrot	Clean, cut into slices and boil in water	12
Pepper	Cut the stem, cut into two pieces, remove the core and boil in water	8 - 10
Spinach	Wash and boil in water	6 - 9

Vegetables and Fruits	Preparation	Maximum storage time (months)
Cauliflower	Remove the leaves, cut the heart into pieces and leave it in water with a little lemon juice for a while	10 - 12
Eggplant	Cut into pieces of 2cm after washing	10 - 12
Corn	Clean and pack with its stem or as sweet corn	12
Apple and pear	Peel and slice	8 - 10
Apricot and Peach	Cut into two pieces and remove the stone	4 - 6
Strawberry and Blackberry	Wash and hull	8 - 12
Cooked fruits	Add 10 % of sugar to the container	12
Plum, cherry, sourberry	Wash and hull the stems	8 - 12

	Maximum storage time (months)	Thawing time at room temperature (hours)	Thawing time in oven (minutes)
Bread	4 - 6	2 - 3	4-5 (220-225 °C)
Biscuits	3 - 6	1 - 1,5	5-8 (190-200 °C)
Pastry	1 - 3	2 - 3	5-10 (200-225 °C)
Pie	1 - 1,5	3 - 4	5-8 (190-200 °C)
Phyllo dough	2 - 3	1 - 1,5	5-8 (190-200 °C)
Pizza	2 - 3	2 - 4	15-20 (200 °C)

Dairy products	Preparation	Maximum storage time (months)	Storage conditions
Packet (Homogenized) Milk	In its own packet	2 - 3	Pure Milk – in its own packet
Cheese - excluding white cheese	In slices	6 - 8	Original packaging may be used for short-term storage. Keep wrapped in foil for longer periods.
Butter, margarine	In its packaging	6	-

PART - 4. CLEANING AND MAINTENANCE



Disconnect the unit from the power supply before cleaning.



Do not wash your appliance by pouring water on it.



Do not use abrasive products, detergents or soaps for cleaning the appliance. After washing, rinse with clean water and dry carefully. When you have finished cleaning, reconnect the plug to the mains supply with dry hands.

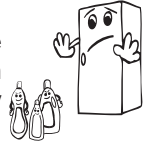

- Make sure that no water enters the lamp housing and other electrical components.

- The appliance should be cleaned regularly using a solution of bicarbonate of soda and lukewarm water.

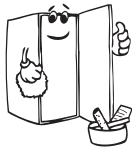
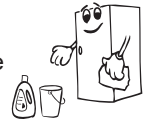

- Clean the accessories separately by hand with soap and water. Do not wash accessories in a dish washer.



- Clean the condenser with a brush at least twice a year. This will help you to save on energy costs and increase productivity.

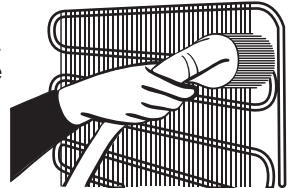

The power supply must be disconnected during cleaning.

Defrosting

- Your appliance performs automatic defrosting. The water formed as a result of defrosting passes through the water collection spout, flows into the vaporisation container behind your appliance and evaporates there.
- Make sure you have disconnected the plug of your appliance before cleaning the vaporisation container.

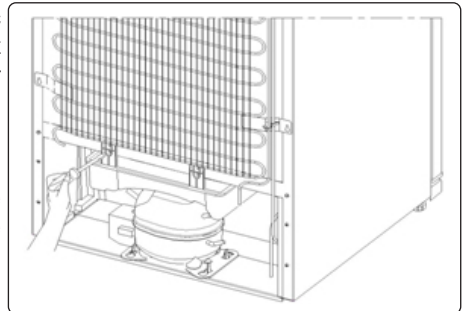

- Remove the vaporisation container from its position by removing the screws as indicated. Clean it with soapy water at specific time intervals. This will prevent odours from forming.

Replacing LED Lighting

Depending on the model, one LED strip in the freezer is used to illuminate the interior of your appliance.

To replace any of the LEDs, please contact the nearest Authorised Service Centre.

 Some versions may not include freezer illumination.

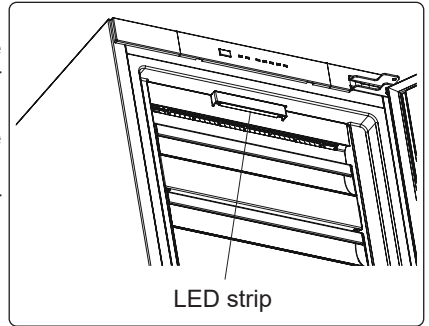

PART - 5.

TRANSPORTATION AND CHANGING OF INSTALLATION POSITION

Transportation and Changing Positioning

- The original packaging and foam may be kept for re-transportation (optional).
- Fasten your appliance with thick packaging, bands or strong cords and follow the instructions for transportation on the packaging.
- Remove all movable parts (drawers, Ice trays and so on) or fix them into the appliance against shocks using bands when re-positioning or transporting.

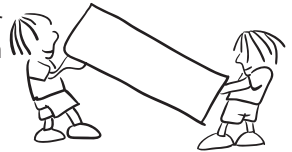

 Always carry your appliance in the upright position.

Repositioning the Door

- It is not possible to change the opening direction of your appliance door if door handles are installed on the front surface of the appliance door.
- It is possible to change the opening direction of the door on models without handles and models with handles mounted on the sides.
- Please refer to the separate document with instructions on installation and door reversal.

 **CAUTION!** At every stage of reversing the door protect the floor from scratching with a durable material.

PART - 6. BEFORE CALLING YOUR AFTER SALES SERVICE

Errors

Your freezer will warn you if the temperatures for the freezer is at improper levels or if a problem occurs with the appliance. In case of a problem within the freezer, the alarm led will release red light.

Alarm indicator LED is turning on	MEANING	WHY	WHAT TO DO
	"Failure" Warning	There is/are some part(s) out of order or there is a failure in the cooling process. The product is plugged for the first time or a long-time power interruption for 1 hour.	Check the door is open or not and check if the product working 1 hour. If the door is not open and the product had worked 1 hour, call service for assistance as soon as possible.

If you are experiencing a problem with your freezer, please check the following before contacting the after-sales service.

Your freezer is not operating

Check if:

- There is power
- The plug is correctly placed in the socket
- The plug fuse or the mains fuse has blown
- The socket is faulty. Examine this by plugging your freezer into a working socket.

What to do if your appliance performs poorly;

Check that;

- You have not overloaded the appliance,
- The freezer temperature set to -16,
- The doors are closed perfectly,
- There is no dust on the condenser,
- There is enough place at the rear and side walls.

Your freezer is operating noisily

Normal noises

Cracking (ice cracking) noise occurs:

- During automatic defrosting
- When the appliance is cooled or warmed (due to expansion of appliance material).

Short cracking noise occurs: When the thermostat switches the compressor on/off.

Motor noise: Indicates the compressor is operating normally. The compressor may cause more noise for a short time when it is first activated.

Bubbling noise and splash occurs: Due to the flow of the refrigerant in the tubes of the system.

Water flowing noise occurs: Due to water flowing to the evaporation container. This noise is normal during defrosting.

Air blowing noise occurs: In No-Frost freezers during normal operation of the system due to the circulation of air.

The edges of the freezer in contact with the door joint are warm

Especially during summer (warm seasons), the surfaces in contact with the door joint may become warmer during the operation of the compressor, this is normal.

The door does not open or close properly

Check if:

- There is food or packaging preventing the door from closing
- The door joints are broken or torn
- Your freezer is on a level surface.

Important Notes:

- In the case of a power failure, or if the appliance is unplugged and plugged in again, the gas in the cooling system of your freezer will destabilise, causing the compressor protective thermal element to open. Your freezer will start to operate normally after 5 minutes.
- If the appliance will not be used for a long period of time (such as during holidays), disconnect the plug. Defrost and clean the freezer, leaving the door open to prevent the formation of mildew and odour.
- If the problem persists after you have followed all the instructions above, please consult the nearest Authorised Service Centre.
- This appliance is designed for domestic use and for the stated purposes only. It is not suitable for commercial or common use. If the consumer uses the appliance in a way that does not comply with these instructions, we emphasise that the manufacturer and the dealer will not be responsible for any repair or failure within the guarantee period.

Hints for Energy Saving

1. Install the appliance in a cool, well-ventilated room, but not in direct sunlight and not near a heat source (such as a radiator or oven) otherwise an insulating plate should be used.
2. Allow warm food and drinks to cool before placing them inside the appliance.
3. Drinks or other liquids should be covered when inside the appliance. If left uncovered, the humidity inside the appliance will increase, therefore the appliance uses more energy. Keeping drinks and other liquids covered helps preserve their smell and taste.
4. Avoid keeping the doors open for long periods and opening the doors too frequently as warm air will enter the appliance and cause the compressor to switch on unnecessarily often.
5. The door gasket must be clean and pliable. In case of wear, if your gasket is detachable, replace the gasket. If not detachable, you have to replace the door.
6. Eco mode / default setting function preserves frozen foods while saving energy.
7. Frozen Compartment (Freezer): The internal configuration of the appliance is the one that ensures the most efficient use of energy.
8. Do not remove the cold accumulators from the freezer basket (if present).

PART - 7.

THE PARTS OF THE APPLIANCE AND THE COMPARTMENTS

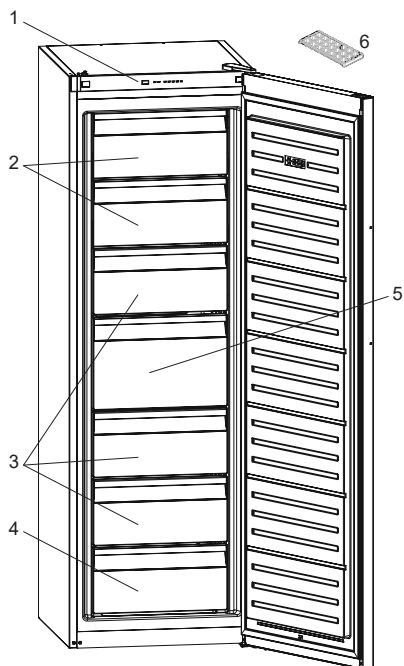

1. Control panel
2. Freezer flaps
3. Freezer drawers
4. Freezer bottom drawer
5. Freezer big drawer
6. Ice tray (*In some models*)

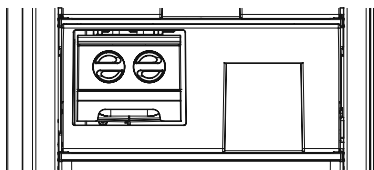

In some models there is a shelf with icematic in the top basket



This presentation is only for information about the parts of the appliance. Parts may vary according to the appliance model.

PART - 8. TECHNICAL DATA

The technical information is situated in the rating plate on the internal side of the appliance and on the energy label.

The QR code on the energy label supplied with the appliance provides a web link to the information related to the performance of the appliance in the EU EPREL database.

Keep the energy label for reference together with the user manual and all other documents provided with this appliance.

It is also possible to find the same information in EPREL using the link <https://eprel.ec.europa.eu> and the model name and product number that you find on the rating plate of the appliance.

See the link www.theenergylabel.eu for detailed information about the energy label.

PART - 9. INFORMATION FOR TEST INSTITUTES

Installation and preparation of the appliance for any EcoDesign verification shall be compliant with EN 62552. Ventilation requirements, recess dimensions and minimum rear clearances shall be as stated in this User Manual at PART 1. Please contact the manufacturer for any other further information, including loading plans.

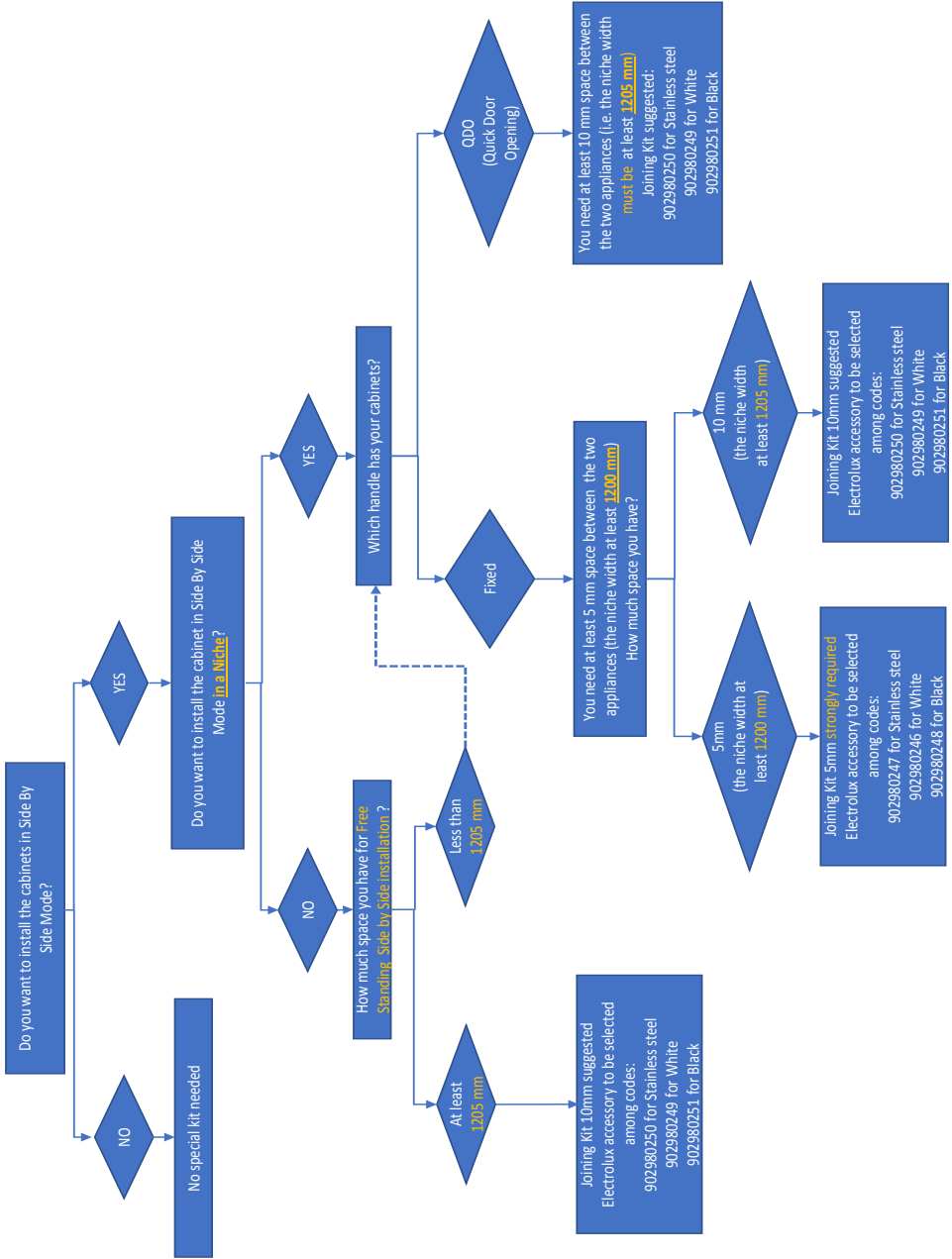

A series of 25 horizontal dotted lines for writing.

www.electrolux.com/shop



PNC CODE: 922717256

