



Brief and handy: everything your dishwasher needs... Before using for the first time, read the operating instructions!

1

Adjusting the water softening system \*

Ask your water supply company what the water hardness is and enter ...

Water-hardness-value °E	Hardness-range	mmol/l	Factory-setting
0-8	soft	0-1.1	0-8
9-10	soft	1.2-1.4	9-10
11-12	medium	1.5-1.8	11-12
13-15	medium	1.9-2.1	13-15
16-20	medium	2.2-2.9	16-20
21-26	hard	3.0-3.7	21-26
27-38	hard	3.8-5.4	27-38
39-62	hard	5.5-8.9	39-62

\* only before the first wash or if the water hardness has been changed

Quickly sorted ...

How to adjust

- Switch on ON/OFF switch
- Press Info button for 3 seconds until the following text is indicated on the display window at the top: **Scroll with <>**
- Set with - +**
- Leave with Setup 3 sec.**
- Keep pressing button > until the water hardness is indicated on the display window at the top.
- Make the setting with setting buttons + -.
- Press and hold the Info button for 3 seconds. The chosen setting has now been stored.

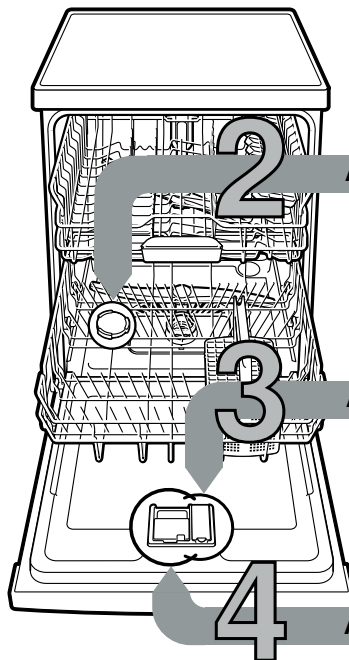

Add special salt

Dissolves limescale (not necessary when set to 0!) ...



Open the lid.



Only fill the salt dispenser with water before the first wash.

For optimal washing results



Add special salt (never use detergent!).



Close the lid. Rinse immediately.

Add rinse aid

Gets it sparkling clean ...



Press marking 1, lift lid 2.



For optimum drying results



Add rinse aid.



Close lid. CLICK!

Add detergent

A lot of dirt, a lot of detergent ...



If required, open the cover (press button).



Attention: Combination products are not suitable for all programmes, follow manufacturer's instructions.

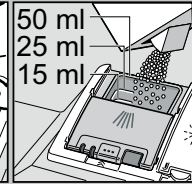

Pour detergent into the dry detergent dispenser only.



Slide cover shut, press. PLOP!

5 Switch on the appliance

6 Select programme

Quick, economical or intensive ...

Overview of programmes

This overview describes all the possible programmes. You can see which programmes your appliance offers from its control panel. The values given in the programme details are laboratory measurements compliant with European standard EN 60436. The consumption figures depend on the selected programme and additional functions. The programme duration will be different if the machine is short of rinse additive or the function is turned off.

- \* half normal load
- \*\* Suitable programme for running at night: it takes longer, but is extremely quiet.

	Intensive 70°	Auto 45°/65°	Eco 50°	Silence ** 50°	Speed 65°	Speed 60°	Speed 45°	brilliant Shine	Favourite	Machine Care
Duration in hrs : mins.	2:25 - 2:30	1:40 - 2:40	3:55	4:00	1:00	1:29	0:35 *	1:55 - 2:00	0:15	2:10 - 2:15
Energy consumption in kWh	1,150 - 1,250	0,680 - 1,300	0,645	0,800	1,280	1,050	0,710	0,800 - 0,850	0,050	1,130 - 1,350
Water consumption in litres	10,5 - 13,5	7 - 15,5	9,5	10,5	10,2	11,5	10,5	14 - 16,6	4	13 - 15,2

7 Start the programme Off we go...

8 Switch off the appliance Everything OK...

## Maintenance and care

For perfect rinsing results ...

## Cleaning waste water pump

**Filters**  
... check, if required, clean.

Rotate filter cylinder, remove filter system ...

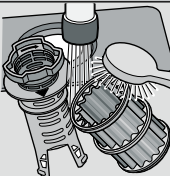

rinse under running water ...

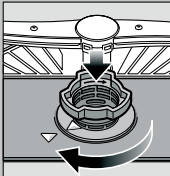

insert ...

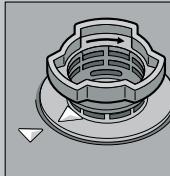

Screw on filter system  
**NOTE MARK!**

- Pull out the mains plug.
- Remove filters and scoop out water.
- Lever off cover (A).
- Check area around the fan impeller for foreign objects.
- Click cover shut (B).
- Insert filters.

**Spray arms**  
... Remove blockages/deposits.

pull lower arm upwards ...

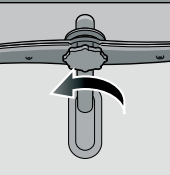

unscrew upper arm ...

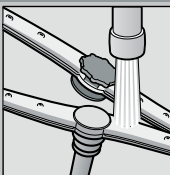

clean spray nozzles under running water (if required use toothpicks) ...

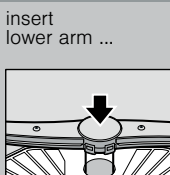

insert lower arm ...  
screw on upper arm tightly



## Rectify small faults yourself ...

... because self-help is worth it!

For more information see the instruction manual

Fault	Possible causes	Solution
Display E3200 and  are lit	Supply fitting jammed or furred up  Water supply not connected	<ul style="list-style-type: none"> <li>▶ Open supply fitting.</li> <li>▶ 1. Unscrew water connection.</li> <li>▶ 2. Clean filter in the water supply.</li> <li>▶ 3. Flow rate must be min. 10 l/min when water supply is open. If the flow rate is less, replace the supply fitting.</li> <li>▶ Install supply hose without kinks.</li> <li>▶ Connect water supply. (Drinking water connection in the instruction manual).</li> </ul>
Display E9240	Filters are soiled or blocked	▶ Clean the filters (see above).
Display E6103 and  are lit	Waste water hose is blocked or kinked Cover of waste water pump not attached	<ul style="list-style-type: none"> <li>▶ Reposition the waste water hose without kinks.</li> <li>▶ Attach cover (see above).</li> </ul>
Display E6102 and  are lit	Waste water pump blocked	▶ Clean waste water pump (see above).
Other error display Exxxx is lit	Appliance technically defective	<ul style="list-style-type: none"> <li>▶ Call customer service (state the error displayed).</li> <li>▶ Unplug the appliance. Turn off the tap.</li> </ul>
Residual water in the appliance	Programme has not yet ended	▶ Close the appliance and switch it on or terminate the programme (see Terminating the programme).
Rust on cutlery	Cutlery not rust-resistant Hard knife blades are more susceptible Extraneous rust	<ul style="list-style-type: none"> <li>▶ Use dishwasher-safe cutlery.</li> <li>▶ Never wash rusting parts in the appliance.</li> </ul>

Fault	Possible causes	Solution
Tableware is not clean Sand or gritty residue on the tableware 	<ul style="list-style-type: none"> <li>Items of tableware lying against or on top of each other</li> <li>Not enough detergent</li> <li>Unsuitable programme selected</li> <li>Spray arm nozzles blocked</li> <li>Filters are soiled, not securely positioned</li> <li>Spray arms blocked</li> </ul>	<ul style="list-style-type: none"> <li>▶ Separate tableware, prevent points of contact.</li> <li>▶ Follow the manufacturer's instructions (detergent).</li> <li>▶ Select a more intensive programme.</li> <li>▶ Clean spray arms (see above).</li> <li>▶ Clean the filters (see above).</li> <li>▶ Arrange tableware so that spray arms can rotate freely.</li> </ul>
Marks and streaks	Rinse aid dosage too high / too low	<ul style="list-style-type: none"> <li>▶ In the case of streaks: reduce detergent dosage.</li> <li>▶ With water or limescale marks: increase dosage.</li> </ul>
Tableware is not dry	Rinse aid The combined detergent used has poor drying performance. Appliance setting	<ul style="list-style-type: none"> <li>▶ Increase dosage. Change product.</li> <li>▶ Use rinse aid.</li> <li>▶ Activate intensive drying (depending on model)</li> </ul>
Milky deposits on the tableware (removable)	Water softening function is wrongly configured; Insufficient special salt	<ul style="list-style-type: none"> <li>▶ Configure water softening system correctly.</li> <li>▶ Add special salt.</li> </ul>
Milky deposits, glasses clouded / opaque (cannot be removed)	Glasses not dishwasher-proof.	<ul style="list-style-type: none"> <li>▶ Use dishwasher-safe glasses.</li> <li>▶ Use gentle detergents for glass.</li> </ul>
Plastic / tableware items discoloured	Not enough detergent Discolouration by food colourings (tomato sauce)	<ul style="list-style-type: none"> <li>▶ Follow the manufacturer's instructions (detergent).</li> <li>▶ Discolouration will not damage the appliance; It will fade after further wash cycles.</li> </ul>

## Terminating the programme ...

## Loading the dishwasher correctly ...

During the programme, press the button for approx. 4 sec. (reset).



The display window shows: Program was terminated.



The programme sequence lasts approx. 1 min. The display window shows: Finished. Switch off ON/OFF switch.

Dishwasher-proof utensils (not soiled with ash, wax, lubricating grease, ink or adhesive labels; remove large remnants of jam, milk products and food according to the operating instructions and check that the spray arms can rotate freely.