



**BOSCH**



**Register** your  
new device on  
MyBosch now and  
get free benefits:  
**[bosch-home.com/  
welcome](https://bosch-home.com/welcome)**

# Washer dryer

**WNA134B0SN WNA134L0SN**

**en** Instruction Manual and Installation Instructions

## Your new washer dryer

You have chosen a Bosch washer dryer.

Please take a few minutes to read and become familiar with the advantages of your washer dryer.

To meet the high quality demands required by Bosch, every washer dryer that leaves our factory is carefully checked to ensure that it functions correctly and is in perfect condition.

For more information on our products, accessories, replacement parts and services, see our website [www.bosch-home.com](http://www.bosch-home.com) or contact our after-sales service centres.

If the operating and installation instructions describe different models, any differences will be pointed out at the relevant points in the text.



Read these operating and installation instructions before switching on the washer dryer.

## Display rules

### **Warning!**

This combination of symbol and signal word indicates a possibly dangerous situation. Not heeding the warning can cause death or injuries.

### **Caution!**

This signal word indicates a possibly dangerous situation. Not heeding the caution can cause property and/or environmental damage.

### **Note/tip**

Information about the optimum use of the appliance/any other useful information.















### **1. 2. 3. / a) b) c)**

The steps are represented by numbers or letters.

■ / -

Lists are represented by a small box or a dash.

# Contents

|  |    |   |    |
|--|----|---|----|
|  <b>Intended use</b> . . . . .               | 4  |  <b>Detergents and care products</b> .27     |    |
|  <b>Safety instructions</b> . . . . .        | 5  | Detergent recommendation . . . . .  | 28 |
| Children/people/pets . . . . .   | 5  |  <b>Overview of programmes</b> . . . . .     | 29 |
| Installation . . . . .   | 6  | Selectable programme . . . . .  | 29 |
| Operation . . . . .  | 8  | Drying table . . . . .  | 33 |
| Cleaning/Maintenance . . . . .   | 10 |  <b>Programme default settings</b> . . . . . | 34 |
|  <b>Environmental protection</b> . . . . .   | 12 | ⌋ (Temperature) . . . . .   | 34 |
| Packaging/used appliance . . . . .   | 12 | Ⓞ (Spin Speed Reduction) . . . . .  | 34 |
| Save energy and conserve resources   | 12 | ⌚ (Finish in/Time Dry) . . . . .  | 34 |
| Energy saving mode . . . . .   | 12 |  <b>Additional programme settings</b> 35     |    |
|  <b>Positioning and connecting</b> . . . . . | 13 | ☀ (Drying Aim) . . . . .  | 35 |
| Standard accessories . . . . .   | 13 | ↓ (Prewash) . . . . .   | 35 |
| Safety instructions . . . . .  | 13 | 👕 (Easy Iron) . . . . .   | 35 |
| Installation surface . . . . .   | 14 | ⌚ (Speed Perfect) . . . . .   | 35 |
| Installation on a base or a wooden joist floor . . . . .   | 14 |  <b>Operating the appliance</b> . . . . .    | 36 |
| Installing the appliance in a kitchenette . . . . .  | 14 | Preparing the appliance . . . . .   | 36 |
| Removing the transport locks . . . . .   | 14 | Select programme/switch on the appliance . . . . .  | 36 |
| Removing the support struts . . . . .  | 15 | Placing laundry into the drum . . . . .   | 36 |
| Hose and cable lengths . . . . .   | 16 | Dosing and adding detergent and care products . . . . .   | 37 |
| Water inlet . . . . .  | 16 | Starting the programme . . . . .  | 38 |
| Water outlet . . . . .   | 17 | Childproof lock . . . . .   | 38 |
| Alignment . . . . .  | 18 | Adding/removing laundry . . . . .   | 39 |
| Electrical connection . . . . .  | 19 | Changing the programme . . . . .  | 39 |
| Before washing for the first time . . . . .  | 19 | Cancel the programme . . . . .  | 39 |
| Transportation . . . . .   | 20 | Programme end . . . . .   | 39 |
|  <b>Getting to know the appliance</b> 22   |    | Removing laundry/switching off the appliance . . . . .  | 40 |
| Appliance . . . . .  | 22 |  <b>Appliance settings</b> . . . . .       | 40 |
| Control panel . . . . .  | 23 |  <b>Sensors</b> . . . . .                  | 41 |
| Display panel . . . . .  | 24 | Unbalanced load detection system . . . . .  | 41 |
|  <b>Laundry</b> . . . . .                  | 25 |  <b>Cleaning and maintenance</b> . . . . . | 41 |
| Preparing laundry for washing . . . . .  | 25 | Appliance housing/control panel . . . . .   | 41 |
| Preparing laundry for drying . . . . .   | 26 | Drum . . . . .  | 42 |
| Starching . . . . .  | 26 | Descaling . . . . .   | 42 |
| Dyeing/bleaching . . . . .   | 26 |   |    |

Emptying the detergent draw, cleaning the detergent drawer and its housing 42  
Drain pump is blocked . . . . . 43  
The drain hose at the siphon is blocked . . . . . 44  
Filter in the water supply is blocked 44

 **Faults and what to do about them**  
45

Emergency release . . . . . 45  
Information on the display panel . . . 46  
Faults and what to do about them . . 47

 **Customer Service . . . . . 51**

Product number (E-Nr.) and production number (FD) . . . . . 51

 **Consumption values . . . . . 52**

 **Technical data . . . . . 53**

 **Aqua-Stop warranty . . . . . 53**

---

 **Intended use**

- This appliance is intended for private domestic use only.
- Do not install or operate this appliance anywhere that is liable to experience frost and/or outdoor conditions. There is a risk that the appliance will be damaged if residual water in it freezes. If hoses freeze up, they may crack/burst.
- This appliance must only be used for washing domestic laundry, consisting of machine-washable items and hand-washable woollens (see label on item). Using the appliance for any other purpose is outside of the scope of its intended application and is forbidden.
- This appliance must only be used for drying and freshening up domestic laundry, consisting of items that have been washed with water and are suitable for tumble drying (see label on item). Using the appliance for any other purpose is outside of the scope of its intended application and is forbidden.
- This appliance is suitable for operation with mains water and commercially available detergents and care products (must be suitable for use in washing machines).
- This appliance is intended for use up to a maximum height of 4000 metres above sea level.

**Before you switch on the appliance:**

Check that there is no visible damage to the appliance. Do not operate the appliance if it is damaged. Should you have any problems, please contact your specialist dealer or our customer service.

Read and follow the operating and installation instructions and all other information provided with this appliance.

Retain the documents for subsequent use or for subsequent owners.

## Safety instructions

The following safety information and warnings are provided to protect you from injury and to prevent material damage to your surroundings.

It is nevertheless important to take the necessary precautions and to proceed with care when installing, maintaining, cleaning and operating the appliance.

### Children/people/pets

#### **Warning** **Risk of death!**

Children and other people who are unable to assess the risks involved when using the appliance may injure themselves or may find themselves in life-threatening situations. Therefore please note:

- The appliance may be used by children over the age of 8 years and by persons with reduced physical, sensory or mental capacity or by persons with a lack of experience or knowledge as long as they are supervised or have received instruction on how to use the appliance safely and they have understood the potential risks of using the appliance.
- Children must not play with this appliance.

- Do not allow children to clean or maintain this appliance unsupervised.
- Keep children under 3 years and pets away from this appliance.
- Do not leave the appliance unattended when children or other people who are unable to assess the risks are in the vicinity.

#### **Warning** **Risk of death!**

Children may lock themselves inside appliances and find themselves in a life-threatening situation.

- Do not position the appliance behind a door, as this may obstruct the appliance door or prevent it from opening completely.
- Once an appliance has reached the end of its life, pull the mains plug from the socket **before** severing the mains cable, and then destroy the lock on the appliance door.

#### **Warning** **Risk of suffocation!**

If allowed to play with the packaging/plastic film or packing components, children may become caught in these or pull them over their heads and suffocate.

Keep packaging, plastic film and packing components away from children.

**⚠ Warning**

**Risk of poisoning!**

Detergents and care products may result in poisoning if consumed.

If accidentally swallowed, seek medical advice. Keep detergents and care products out of the reach of children.

**⚠ Warning**

**Eye/skin irritation!**

Contact with detergents or care products may cause eye/skin irritation.

Rinse eyes/skin thoroughly if they/it come(s) into contact with detergents or care products. Keep detergents and care products out of the reach of children.

**Installation**

**⚠ Warning**

**Risk of electric shock/fire/  
material damage/damage to  
the appliance!**

If the appliance is not installed properly, this may lead to a dangerous situation. Ensure the following:

- The mains voltage on your power socket must match the rated voltage specified on the appliance (identification plate). The connected loads and the required fuse protection are specified on the identification plate.

- The appliance must not be supplied through an external switching device, such as a timer, or connected to a circuit that is regularly switched on and off by a utility.
- The mains plug and the protective contact socket must match and the earthing system must be correctly installed.
- The installation must have an adequate cross section.
- The mains plug must be freely accessible at all times. If this is not possible, in order to comply with the relevant safety regulations, a switch (all pole disconnection) must be built into the permanent installation in accordance with electrical installation regulations.
- If using a residual current circuit breaker, only use one that bears the following mark: . The presence of this mark is the only way to be sure that it fulfils all the applicable regulations.

**⚠ Warning**

**Risk of electric shock/fire/  
material damage/damage to  
the appliance!**

If the appliance's mains cable is altered or damaged, this may result in electric shock, short circuiting or fire due to overheating.

The mains cable must not be kinked, crushed or altered, and must not come into contact with any heat sources.

**⚠ Warning**  
**Risk of fire/material damage/  
 damage to the appliance!**

The use of extension cords or power strips may result in fire due to overheating or short circuiting.

Connect the appliance directly to an earthed socket that has been correctly installed. Do not use extension cords, power strips or multi-way couplers.

**⚠ Warning**  
**Risk of injury/material  
 damage/damage to the  
 appliance!**

- The appliance may vibrate or move when in operation, potentially resulting in injury or material damage. Place the appliance on a clean, even, solid surface and, using a spirit level to guide you, level it with the screw-in feet.
- If you take hold of any of the appliance's protruding parts (e.g. the appliance door) in order to lift or move it, these parts may break off and cause injury. Do not take hold of any of the appliance's protruding parts in order to move the appliance.

**⚠ Warning**  
**Risk of injury!**

- The appliance is very heavy. Lifting it may result in injury. Do not lift the appliance on your own.
- The appliance has sharp edges on which you could cut your hands. Do not take hold of the appliance by its sharp edges. Wear protective gloves to lift it.
- If the hoses and mains cables are not correctly routed, they may constitute a tripping hazard, which may result in injury. Route hoses and cables such that they do not constitute a tripping hazard.

**Caution!**  
**Material damage/damage to  
 the appliance**

- If the water pressure is too high or too low, the appliance may not be able to operate properly, and it may also result in material damage or damage to the appliance. Make sure that the water pressure in the water supply facility is at least 100 kPa (1 bar), and does not exceed 1000 kPa (10 bar).

- If the water hoses are altered or damaged, this may result in material damage or damage to the appliance. The water hoses must not be kinked, crushed, altered or severed.
- The use of hoses supplied by other brands to connect to the water supply may result in material damage or damage to the appliance. Use the hoses supplied with the appliance or genuine spare part hoses only.
- The appliance is secured for transportation by transport locking devices. If the transport locking devices are not removed before the appliance is operated, this may result in damage to the appliance.  
It is important to completely remove all transport locking devices before using the appliance for the first time. Make sure that you retain these transport locking devices separately. It is important to refit the transport locking devices if the appliance is to be transported, in order to prevent the appliance from being damaged in transit.

## Operation

### **Warning**

#### **Risk of explosions/fire!**

Laundry that has come into contact with solvents, oil, wax, wax remover, paint, grease or stain remover may ignite when dried in the machine, or even cause the appliance to explode. Therefore please note:

- Rinse the laundry thoroughly with warm water and detergent before drying it in the machine.
- Do not place laundry in this appliance to be dried if the laundry has not been washed first.
- Do not use the appliance if industrial chemicals have been used to clean the laundry.

### **Warning**

#### **Risk of explosions/fire!**

- Laundry that has been pretreated with cleaning agents that contain solvents, e.g. stain remover/cleaning solvent, may cause an explosion in the drum. Rinse the laundry thoroughly with water before washing it in the machine.



- Certain objects may ignite when drying is in progress, or even cause the appliance to catch fire or explode. Remove any lighters or matches from pockets on items of clothing.
- If there is coal dust or flour in the air around the appliance, this may cause an explosion. Make sure that the area around the appliance is kept clean when it is in operation.

### **Warning**

#### **Risk of fire/material damage/damage to the appliance!**

If a program is terminated before the drying cycle has finished, this prevents the laundry from cooling down sufficiently and may cause the laundry to ignite, or may result in material damage or damage to the appliance.

- During the last part of the drying cycle, the laundry in the drum is not heated (cooling cycle). This is to ensure that it remains at a temperature at which it will not be damaged.
- Do not switch off the appliance before the drying cycle has finished unless you remove all items of laundry from the drum immediately and spread them out (to dissipate the heat).

### **Warning**

#### **Risk of poisoning!**

Poisonous fumes may be given off by cleaning agents that contain solvents, e.g. cleaning solvent.

Do not use cleaning agents that contain solvents.

### **Warning**

#### **Risk of injury!**

- If you support your weight/sit on the appliance door when it is open, the appliance may tip over, which may result in injury.  
Do not support your weight on the appliance door when it is open.
- If you climb onto the appliance, the worktop may break, which may result in injury.  
Do not climb onto the appliance.
- If you reach into the drum while it is still rotating, you risk injuring your hands.  
Wait until the drum has stopped rotating.

### **Warning**

#### **Risk of scalding!**

When washing at high temperatures, there is a risk of scalding if you come into contact with hot detergent solution (e.g. when draining hot detergent solution into a washbasin).

Do not reach into the hot detergent solution.

 **Warning**

**Eye/skin irritation!**

Detergent and care products may spray out if the detergent drawer is opened while the appliance is in operation. Rinse eyes/skin thoroughly if they/it come(s) into contact with detergents or care products. If accidentally swallowed, seek medical advice.

**Caution!**

**Material damage/damage to the appliance**

- If the amount of laundry in the appliance exceeds its maximum load capacity, it may not be able to operate properly, or this may result in material damage or damage to the appliance. Do not exceed the maximum load capacity of dry laundry. Make sure you comply with the maximum load capacities specified for each of the programs.
- Foam and foam rubber may deform or melt if dried in the appliance. Do not dry laundry items that contain foam or foam rubber in the appliance.

- If you pour the wrong quantity of detergent or cleaning agent into the appliance, this may result in material damage or damage to the appliance. Use detergents/care products/cleaning agents and softeners in accordance with the manufacturers' instructions.

**Cleaning/Maintenance**

 **Warning**  
**Risk of death!**

The appliance is powered by electricity. There is a risk of electric shock if you come into contact with live components. Therefore please note:

- Switch off the appliance. Disconnect the appliance from the power supply (pull out the plug).
- Never take hold of the mains plug with wet hands.
- When removing the mains plug from the socket, always take hold of the plug itself and never the mains cable, otherwise this may damage the mains cable.
- Do not make any technical modifications to the appliance or its features.

- Repairs and any other work on the appliance must only be conducted by our customer service or by an electrician. The same applies for replacing the mains cable (when necessary).
- Spare mains cables can be ordered from our customer service.

**⚠ Warning**  
**Risk of poisoning!**

Poisonous fumes may be given off by cleaning agents that contain solvents, e.g. cleaning solvent.  
Do not use cleaning agents that contain solvents.

**⚠ Warning**  
**Risk of electric shock/material damage/damage to the appliance!**

If moisture penetrates the appliance, this may cause it to short circuit.  
Do not use a pressure washer, steam cleaner, hose or spray gun to clean your appliance.

**⚠ Warning**  
**Risk of injury/material damage/damage to the appliance!**

The use of spare parts and accessories supplied by other brands is dangerous and may result in injury, material damage or damage to the appliance.  
For safety reasons, use genuine spare parts and accessories only.

**Caution!**  
**Material damage/damage to the appliance**

Cleaning agents and agents for pretreating laundry (e.g. stain removers, prewash sprays, etc.) may cause damage if they come into contact with the surfaces of the appliance.  
Therefore please note:

- Do not allow these agents to come into contact with the surfaces of the appliance.
- Clean the appliance with nothing but water and a soft, damp cloth.
- Remove any detergent, spray or other residues immediately.



## Environmental protection

### Packaging/used appliance



Dispose of packaging in an environmentally-responsible manner.

This appliance is labelled in accordance with European Directive 2012/19/EU concerning used electrical and electronic appliances (waste electrical and electronic equipment - WEEE).

The guideline determines the framework for the return and recycling of used appliances as applicable throughout the EU.

### Save energy and conserve resources

If you follow these instructions, your appliance will use less electricity and less water.

Choose programmes with low temperatures and longer wash times and use maximum load capacity  
→ *Page 29*.

- Energy consumption and water consumption is most efficient.

Use the economy programme settings.

- If you adjust the programme settings for a programme, the display shows the expected consumption.

Add → *Page 28* detergent based on the laundry's degree of soiling.

- For light to normal soiling, a smaller amount of detergent is sufficient. Observe the dosage recommendation from the detergent manufacturer.

Reduce the washing temperature for lightly and normally soiled laundry.

- At low temperatures, the appliance consumes less energy. For light to normal soiling, lower temperatures than indicated on the care label are also sufficient.

Set the maximum spin speed if you want to dry the laundry in a tumble dryer afterwards.

- The drier the laundry, the shorter the programme duration when drying which, in turn, reduces energy consumption. A higher spin speed reduces the residual moisture in the laundry and increases the volume of the spin noise.

Wash the laundry without prewash.

- Washing with prewash increases the programme duration and increases energy and water consumption.

The appliance has a continuous automatic load adjustment function.

- Depending on the type of fabric and load capacity, the continuous automatic load adjustment function optimally adjusts the water consumption and programme duration.

### Energy saving mode

If the appliance is not operated for a prolonged period (approx. 5 minutes), it automatically switches to energy-saving mode, the display panel lighting goes out before the programme starts and after the programme has ended, — (The indicator of  button) flashes. Touch any area of display panel to activate the display backlighting.

energy saving mode is not be activated when the programme is running.

## Positioning and connecting

### Standard accessories

**Note:** Check the appliance for transport damage. Never use a damaged appliance. If you have any complaints, contact the dealer from whom you purchased the appliance or our Customer Service.

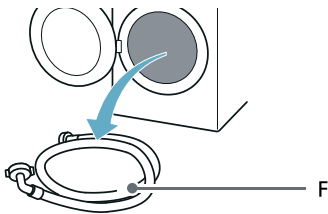
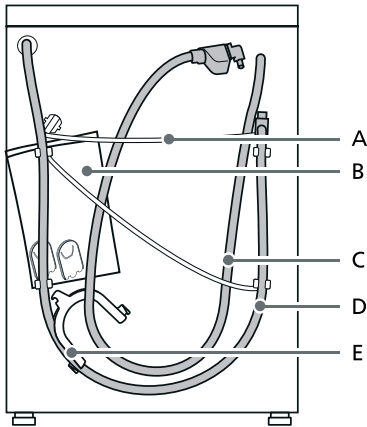

A Mains lead

- B Bag:
- Installation and operating instructions
  - Customer Service location directory\*
  - Warranty\*
  - Supplementary sheet for the installation and operating instructions\*
  - Cover caps for openings after the transport braces have been removed
  - Home Connect Installation Guides\*
- C Water inlet hose on aquaStop models
- D Water outlet hose
- E Elbow for securing the water outlet hose\*
- F Cold water inlet hose on Standard/Aqua-Secure models
- \* Depending on the model

**In addition,** a hose clamp (24 - 40 mm diameter, available from specialist retailers) is required to connect the water outlet hose to a siphon.

### Useful tool

- Spirit level for aligning
- Wrench with:
  - WAF13 for loosening the transport braces and
  - WAF17 for aligning the appliance feet

## Safety instructions

### **Warning** **Risk of injury!**

- The appliance is very heavy. Be careful when lifting/transporting the appliance.
- When the appliance is lifted by its protruding parts (e.g. the appliance door), the components may break off and cause injuries. Do not lift the appliance by protruding parts.

## en Positioning and connecting

- If the hose and mains cables are not routed properly, there is a risk of tripping and injury.  
Lay hoses and cables in such a way that there is no risk of tripping.

### Caution!

#### Damage to the appliance

Frozen hoses may rip/burst.  
Do not install the appliance in areas exposed to frost or outdoors.

### Caution!

#### Water damage

The connection points for the water supply hose and water drain hose are under high water pressure. To prevent leaks and water damage, you must follow the instructions in this section.

### Notes

- In addition to the safety information listed here, the local water and electricity supplier may have special requirements.
- If in doubt, have the appliance connected by a specialist.

## Installation surface

**Note:** The appliance must be stable aligned so that it does not move around.

- The installation surface must be firm and level.
- Soft floors/floor coverings are not suitable.

## Installation on a base or a wooden joist floor

### Caution!

#### Damage to the appliance

The appliance may "wander" and tip/topple from the base when spinning. The feet of the appliance must be secured with holding brackets.  
Order no. WMZ 2200, WX 975600, CZ 110600, Z 7080X0.

**Note:** On wooden joist floors, install the appliance:

- In a corner, if possible,
- On a water-resistant wooden board (min. 30 mm thick) which is screwed tightly to the floor.

## Installing the appliance in a kitchenette



### Warning Risk of death!

There is a risk of electric shock if you touch live components.  
Do not remove the appliance covering plate.

### Notes

- Recess width of 60 cm required.
- Only install the appliance underneath a continuous worktop that is securely connected to adjacent cabinets.

## Removing the transport locks

### Caution!

#### Damage to the appliance

- The appliance is secured for transportation using transport locks. If the transport locks are not removed, the appliance may become damaged when it is operated.  
Before using the appliance for the first time, make sure that you completely remove all four transport locks. Keep the locks in a safe place.
- To prevent transport damage from occurring if the appliance is moved at a later date, you must refit the transport locks before transporting the appliance.

**Note:** Keep the screws and sleeves in a safe place.

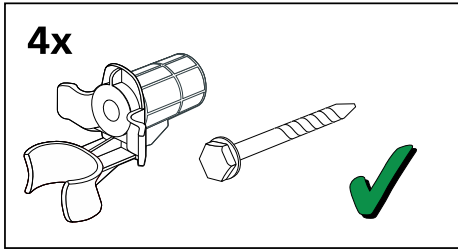

1. Take the hoses out of the holders.

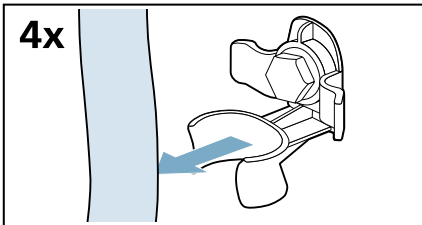

2. Unscrew and remove all four transport brace screws.

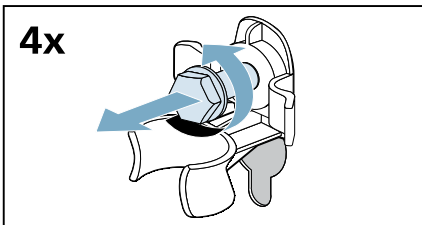

- a) Remove the mains cable from the holders.

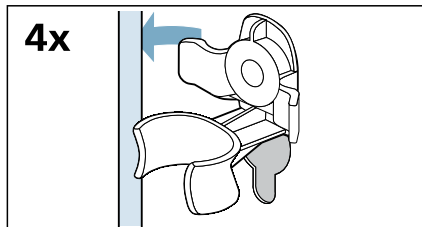

- b) Remove the sleeves.

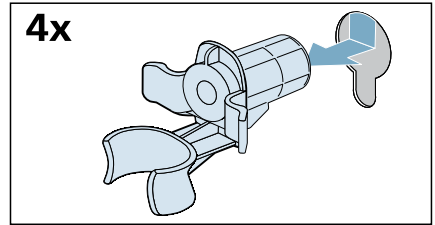

3. Fit the covers.

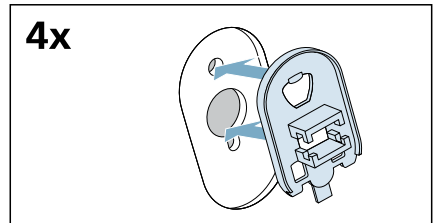

4. Lock the covers firmly in place by applying pressure to the snap-in hooks.

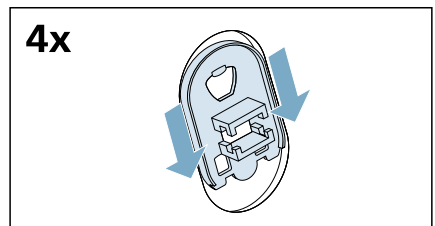

## Removing the support struts

1. Unscrew and remove all screws in the vertical transport struts.

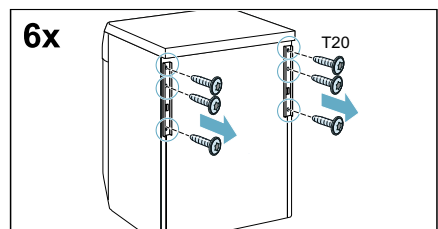

**en** Positioning and connecting

**2.** Remove the transport struts.

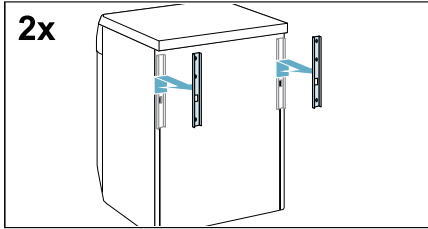

**Hose and cable lengths**

**Connection on left side**

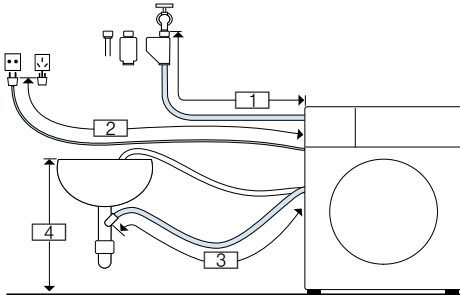

- 1 ~ 105 cm
- 2 ~ 145 cm
- 3 ~ 95 cm
- 4 60 cm ~ 100 cm

or

**Connection on right side**

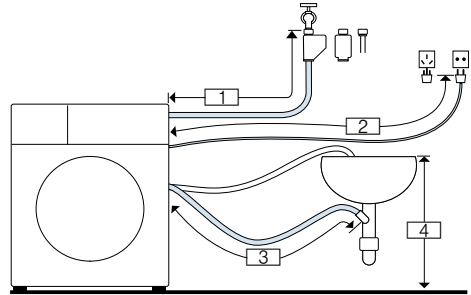

- 1 ~ 60 cm
- 2 ~ 195 cm
- 3 ~ 140 cm
- 4 60 cm ~ 100 cm

**Note:** If the supply hose is too short for your connection, you can order an extension from the after-sales service.

**Water inlet**

**⚠ Warning**  
**Risk of death!**

There is a risk of electric shock if you touch live components. Do not immerse the Aqua-Stop safety valve\* in water (it contains an electric valve).

\* Depending on the model

Observe the following when connecting the appliance:

**Notes**

- Only operate the appliance using cold mains water.
- Do not connect the appliance to the mixer tap of an unpressurised hot-water boiler.
- Do not use a used supply hose. Only use the supply hose supplied or one that was purchased from an authorised specialist retailer.



- Do not bend, squash, modify or cut through the water supply hose (otherwise its strength is no longer guaranteed).
- Only tighten the screw connections by hand. If the screw connections are tightened too much with a tool (pliers), the thread may be damaged.

### Optimum water pressure in the supply network

**At least** 100 kPa (1 bar)

**Maximum** 1000 kPa (10 bar)

When the tap is open, the water flow is at least 8 l/min.

If the water pressure is higher than this, a pressure-reducing valve must be installed.

### Connection

1. Connect the water supply hose to the water tap ( $\frac{3}{4}$ " = 26.4 mm) and to the appliance:

– Model: **Standard**

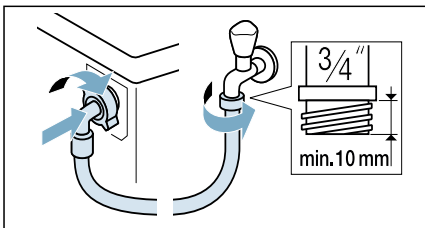

– Model: **Aqua-Secure**

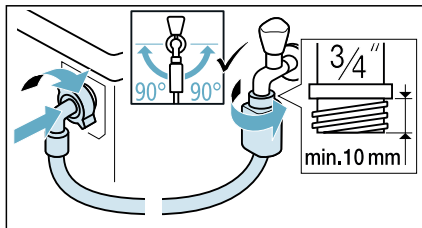

– Model: **Aqua-Stop**

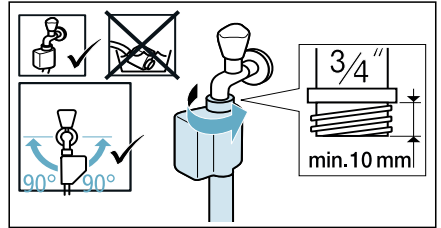

**Tip:** Connect also an external water filter (depending on the model) between water supply hose and tap. The filter filters dirt particles out of the water.

Water filter must be cleaned regularly to remove contaminants. This will prevent blockages. See also → separate installation and cleaning instruction for water filter.

2. Open the water tap carefully, checking the leak tightness of the connection points. The screw connection is under mains water pressure.

### Water outlet

#### **Warning** **Risk of scalding!**

When you are washing at high temperatures, there is a risk of scalding if you come into contact with hot water (e.g. when draining hot water into a washbasin). Do not reach into the hot water.

#### **Caution!** **Water damage**

When water is being pumped away, the outlet hose is under water pressure and may slip out of the wash basin or connection point. Secure the drain hose so that it cannot slip out.

**Caution!**

**Damage to the appliance/fabrics**

If the end of the drain hose is immersed in the drained water, water may be sucked back into the appliance and may damage the appliance/fabrics. Make sure that:

- The plug does not block drainage from the washbasin.
- The end of the drain hose is not immersed in the drained water.
- The water drains away quickly enough.

**Note:** Do not kink the water drain hose or put strain on it lengthways.

**Connection**

■ **Drainage into a siphon**

The connection point must be secured using a hose clamp with a diameter of 24 - 40 mm (available from specialist dealers).

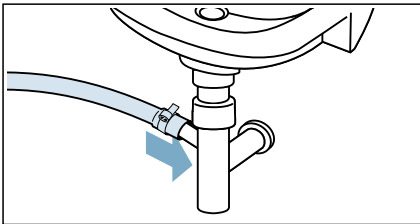

■ **Drainage into a washbasin**

Secure the outlet hose so that it cannot slip out. Elbow available from after-sales service: Individual part number 00655300

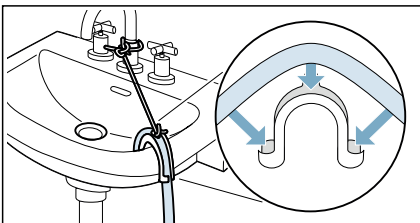

- **Drainage into a plastic pipe with rubber bushing or into a drainage pit**

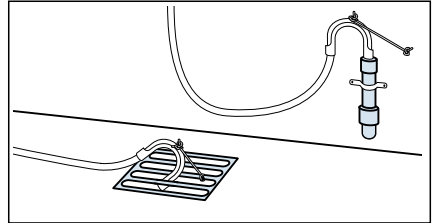

**Note:** The plastic pipe is not standard accessory, available from specialist dealers.

**Alignment**

Level the appliance using a spirit level. Incorrect levelling may result in intense noise, vibrations and "wandering".

1. Loosen the lock nuts using a wrench, by turning it in a clockwise direction.

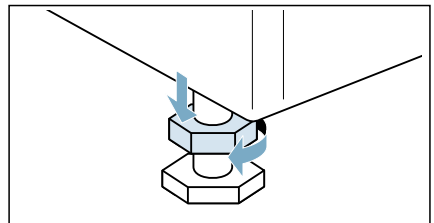

2. Check the alignment of the appliance with a spirit level, and adjust it if necessary. Change the height by turning the appliance feet. All four appliance feet must stand firmly on the ground.

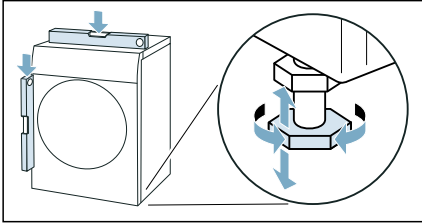

3. Tighten the lock nut against the housing. In doing so, hold the foot tight and do not adjust its height. The lock nuts on all four appliance feet must be screwed tightly against the housing.

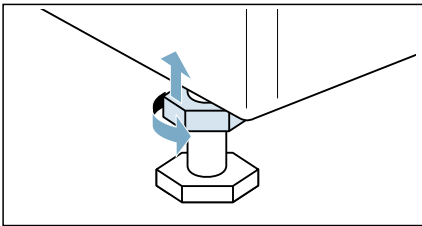

## Electrical connection

### **⚠ Warning** **Risk of death!**

There is a risk of electric shock if you touch live components.

- Never touch or hold the mains plug with wet hands.
- Only pull out the mains cable by the plug and never by the cable, as this could damage it.

Observe the following information and ensure that:

### Notes

- The mains voltage and voltage indicated on the appliance (rating plate) are the same. The connected load and fuse required are specified on the rating plate.
- The appliance is only connected to an alternating current via a properly installed earthed socket.
- The mains plug fits the socket.
- The earthing system is properly installed.
- The mains cable is only replaced by a qualified electrician (if this is necessary). Replacement mains cables are available from the after-sales service.
- No multiple plugs/couplings or extension cables are used.
- If an earth-leakage circuit breaker is used, only a type which displays this symbol is used: . Only this symbol guarantees compliance with the currently applicable regulations.
- The mains plug can be accessed at all times.
- The mains cable is not bent, squashed, modified, cut through, or in contact with heat sources.

## Before washing for the first time

The appliance was inspected thoroughly before leaving the factory. To remove any residual test water, run the **Cotton 90°C** programme the first time **without** laundry.

### Note:

- The appliance must have been installed and connected properly. → *"Positioning and connecting" on page 13*
- Never switch on a damaged appliance.

## en Positioning and connecting

1. Insert mains plug.
2. Turn the water tap on.
3. Close the door. Do not load any laundry.
4. Select the **Cotton 90°C** programme.
5. Open the detergent drawer.
6. Pour approx. 1 litre of water into dispenser II.
7. Add standard detergent to dispenser II according to manufacturer's instructions for light soiling.  
**Note:** To prevent frothing, use only half the recommended amount of detergent. Do not use any woollens or mild detergents.
8. Close the detergent drawer.
9. Select **▷||| (Start/Reload/Pause)**.
10. When the programme ends, turn the programme selector to **Av (Off)**.

**Your appliance is now ready for use.**

## Transportation

e.g. when moving home

### Preparatory work:

1. Turn off the water tap.
2. Reduce the water pressure in the supply hose. → *Page 44*
3. Drain any residual water.  
→ *Page 43*
4. Disconnect the appliance from the mains.
5. Remove the hoses.
6. Empty the dispensers.

### Caution!

#### **Risk of damage to the appliance caused by detergent/fabric softener leaking from the dispensers**

Leaking detergent/fabric softener can prevent the appliance from working correctly, e.g. due to damage to the electronics. Empty the dispensers before transporting the appliance.

### Installing the transport locks:

1. Remove the covers and keep them in a safe place.

**Note:** Use a screwdriver if necessary.

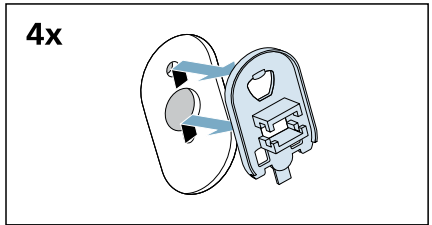
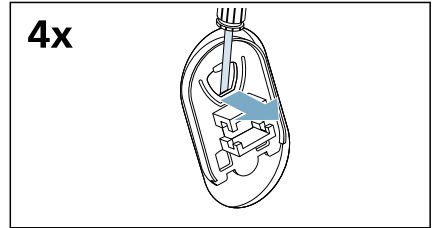

2. Insert all four sleeves.

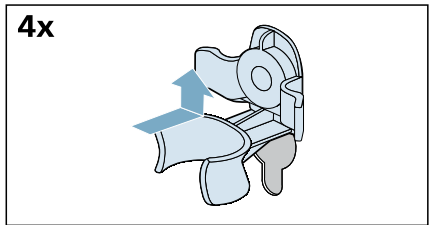

- a) Clip the mains cable securely in the holders.

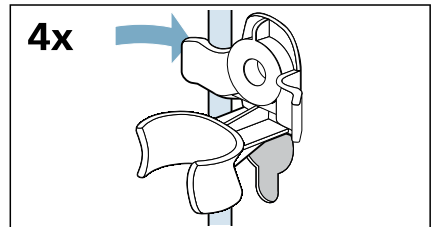

b) Insert and tighten the screws.

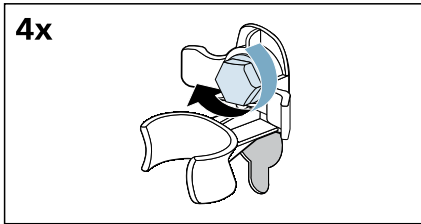

c) Clip the hoses securely in the holders.

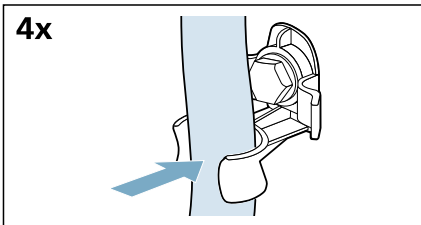

**Before switching on the appliance again:**

#### Notes

- The support struts **must** be removed.  
→ *"Removing the support struts" on page 15*
- The transport braces **must** be removed.  
→ *"Removing the transport locks" on page 14*
- Pour approx. 1 litre of water into dispenser II, select the **Drain** programme and start.  
This will prevent detergent from flowing straight into the drain during the next wash.

## Getting to know the appliance

### Appliance

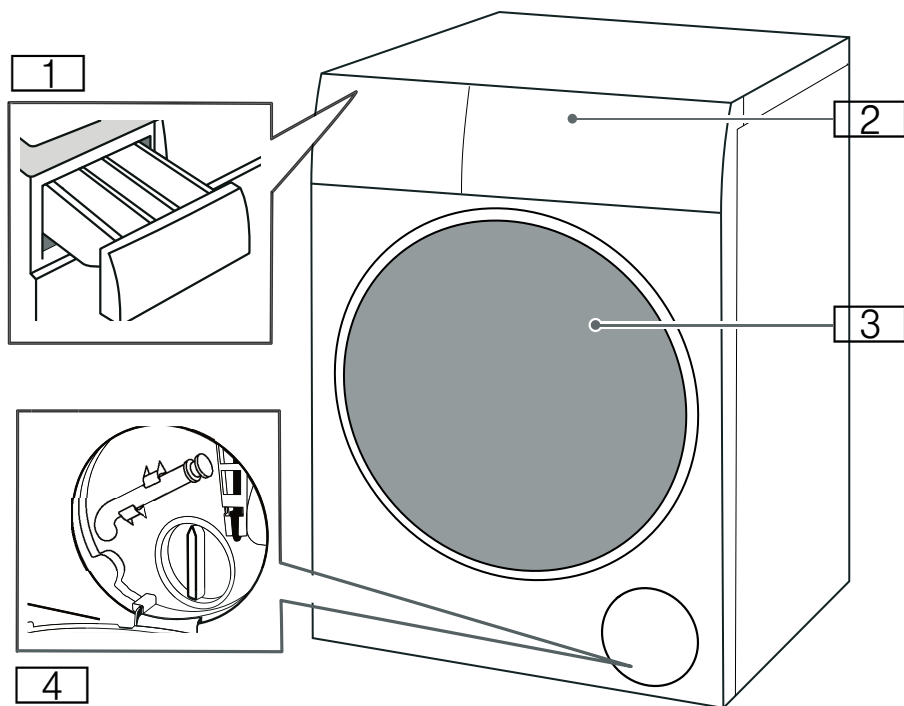

- 1 Detergent drawer
- 2 Control panel
- 3 Loading door
- 4 Service flap

## Control panel

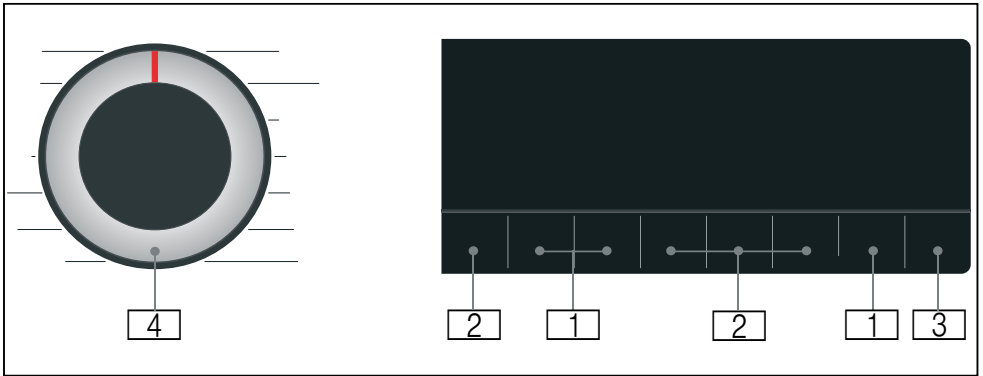

- 1** **Programme default settings** can be changed.  
Overview of all programme default settings → *Page 34*
- 2** **Additional programme settings** can be selected.  
Overview of all additional programme settings → *Page 35*
- 3** **▶||| (Start/Reload/Pause)** button for starting, interrupting, (e.g. adding laundry) and cancelling a programme.
- 4** **Programme selector** for selecting the programme and for switching the appliance on and off.

## Display panel

### Programme default settings

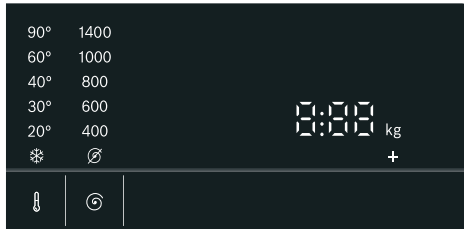

| Display  | Setting                         | Description  |
|--|---------------------------------|--|
| * - 90°  | 🌡️ (Temperature)                | Temperature that can be set in °C<br>* = cold  |
| ∅ - 1400*  | 🌀 (Spin Speed Reduction)        | Spin speed in rpm (revolutions per minute)<br>∅ = No spin                            |
| 2:30*  | Programme remaining time        | Programme remaining time depends on the programme selection in h:min (hours:minutes) |
| 0,5 - 24 h                                       | 🕒 (Finish in/ Time Dry)         | Programme ends after ... h (h = hours)   |
| 8,0* kg/<br>5,0* kg                              | Maximum load for washing/drying | Recommended load in kg   |
| * Depending on the selected model and programme. |                                 |  |

### Additional programme settings

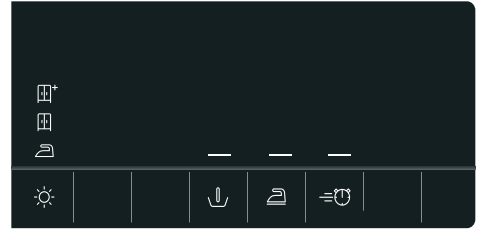

| Display | Setting           |
|---------|-------------------|
| ☀️*/👕/👕 | ☀️ (Drying Aim)   |
| —       | ↓ (Prewash)       |
| —       | 👕 (Easy Iron)     |
| —       | ⚡ (Speed Perfect) |

### Status indicators for the programme progress (programme sequence)

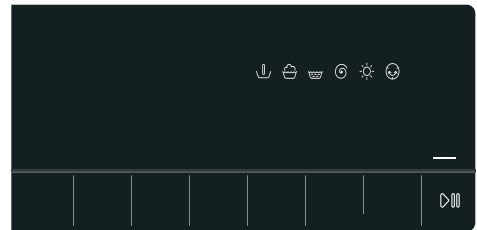

| Display | Setting                  |
|---------|--------------------------|
| —       | ▶️👕 (Start/Reload/Pause) |
| ↓       | Prewash                  |
| 👕       | Wash                     |
| 👕       | Rinse                    |
| 🌀       | Spin/Drain               |
| ☀️      | Dry                      |
| 😊       | Wrinkle guard            |
| End     | Programme end            |





## Laundry

### Preparing laundry for washing

#### Protecting your laundry and appliance

##### Caution!

##### Damage to the appliance/textiles







Foreign objects (e.g. coins, paper clips, needles, nails) may damage the washing or components of the appliance.

The following instructions must be observed when preparing your laundry:

- Always follow the manufacturer's instructions when dosing all detergents, cleaning aids, care products and cleaning agents.
- Do not exceed maximum load. Overfilling will impair the washing result.
- Keep detergents and agents for the pretreatment of laundry (e.g. stain remover, prewash sprays, etc.) away from the surfaces of the appliance. Using a damp cloth, immediately remove any fine spray residue and other residue or droplets.
- Empty any pockets. Remove any foreign objects.
- Remove metal parts (paper clips, etc.).
- Trousers, knitwear and knitted textiles, e.g. jersey garments, T-shirts or sweatshirts, should be turned inside out.
- Ensure that underwired bras are appliance-washable.
- Wash delicates in a net or bag (tights, underwired bras, etc).
- Close zips, button up covers.
- Brush sand out of pockets and collars.
- Remove curtain fittings or place in a net/bag.

### Sorting laundry

Sort your laundry according to the care instructions and manufacturer's information on the care labels, depending on:

- Type of fabric/fibre
  - Colour
- Note:** Laundry may discolour. Wash white and coloured items separately. Wash new coloured items separately the first time you wash them.
- Soiling
    - Wash laundry with the same level of soiling together.
      - **Light:** No need to pretreat, adjust the  (**Speed Perfect**) setting if necessary.
      - **Normal**
      - **Heavy:** Load less laundry, need to pretreat or soak laundry firstly.
      - **Stains:** Remove/pretreat stains while they are fresh. First dab with soapy water; do not rub. Then wash the items of laundry with the appropriate programme. Stubborn or dried-in stains can sometimes only be removed by washing several times.
  - Symbols on the care labels
    -  Suitable for normal washing process; e.g. Cotton programme
    -  A gentle washing process is required; e.g. Easy Care programme
    -  An especially gentle washing process is required; e.g. Delicate/Silk programme
    -  Suitable for washing by hand; e.g. Wool/ Handwash  programme
    -  Do not machine wash.

## Preparing laundry for drying

**Note:** To ensure an even drying result, sort the laundry according to the:

- Type of fabric
- Care symbols which are indicated on the care labels.

Only dry laundry which is labelled “dryer-proof” or which has the following care symbols:

- ☒: You can select **Intensive Dry**
- ☑: You can select **Gentle Dry**

The following textiles must not be dried:

- ☒ = care symbol “Do not dry”
- Delicates (silk, synthetic curtains).
- Textiles which contain foam rubber or similar materials.
- Textiles which were treated with flammable liquids, e.g. with stain remover, petroleum ether, thinners. Risk of explosion!
- Textiles which still contain hairspray or similar substances.

### Notes

- Before drying, hand-washed textiles must be spun at the appropriate spin speed.
- Before drying, spin at the optimum speed. A spin speed of more than 1000 rpm is recommended for cotton, more than 800 rpm for easy-care textiles.
- Do not iron washing immediately after drying. It is recommended to roll the washing up first to distribute residual moisture evenly.
- To ensure a good drying performance, quilts, terry cloths and other large textiles should be dried separately.
- Do not exceed the maximum load.

## Starching

**Note:** Laundry should not be treated with fabric softener.

1. Switch on the appliance.
2. Select the **Rinse** programme.
3. Measure starch into dispenser ☒ in accordance with the manufacturer's instructions (clean first if necessary).
4. Touch the ▷||| (**Start/Reload/Pause**) button.

## Dyeing/bleaching

Dye should only be used in normal household quantities. Salt may damage stainless steel. Always follow the dye manufacturer's instructions.

Do **not** use the appliance to bleach clothes.



## Detergents and care products

You can protect your appliance and your laundry by selecting and using the correct detergents and care products. You can use all detergents and care products which are suitable for your appliance.

**Note:** Please read the safety information → *Page 5* to ensure that you use the appliance safely.

The manufacturer's instructions for use and dosage can be found on the packaging.

### Notes

- Only use liquid detergents that are self-flowing
- Do not mix different liquid detergents
- Do not mix detergent and fabric softener
- Do not use products which have developed a top layer or are highly congealed
- Do not use products containing solvents, caustic agents or volatile substances (e.g. bleach)
- Use dyes sparingly as salt may damage stainless steel
- Do not use bleaching agents in the appliance

## Detergent recommendation









This information is intended to help you to choose the right detergent for your items.

































| Fabrics   | Detergent   | Programme      | Temperature           |
|---|---|----------------|-----------------------|
| Heat-resistant white fabrics made from cotton or linen              | Standard detergent with optical brighteners                 | Cottons        | From cold up to 90 °C |
| Coloured fabrics made from linen or cotton                          | Detergent for colours without bleach or optical brighteners | Cottons        | From cold up to 60 °C |
| Coloured fabrics made from easy-care fabrics or synthetic materials | Detergent for colours/delicates without optical brighteners | Easy Care      | From cold up to 60 °C |
| Delicate fabrics made from silk or viscose                          | Delicates   | Delicates/Silk | From cold up to 40 °C |
| Wool  | Detergent for Woollens                                      | Wool           | From cold up to 40 °C |





























**Tip:** Visit [www.cleanright.eu](http://www.cleanright.eu) to find further information on detergents, care products and cleaning agents for domestic use.















## Overview of programmes

### Selectable programme

| Programme/Type of laundry  | Options/Information   |
|--|---|
| <p><b>Name of the programme</b></p> <p>Brief explanation of the programme and for which fabrics it is suitable.</p>  | <p>Max. load for washing/<br/>Max. load for drying</p> <p>Max. load as kg depending on the model and the programme</p> <p>selectable temperature* as °C</p> <p>selectable spin speed* in rpm</p> <p>possible additional programme settings*</p> <p>possible setting for drying* (De)selectable ✓, not selectable -</p> <p>softener</p>  |
| <p><b>Cotton</b></p> <p>Hard-wearing fabrics, heat-resistant fabrics made of cotton or linen.</p> <p><b>Notes</b></p> <ul style="list-style-type: none"> <li>■ The symbol  (drum clean information signal) flashes if you have not used any programme at a temperature of 60°C or higher for an extended period. Do not load any laundry, and select the <b>Cotton 90°C</b> programme to clean and care for the drum and the outer tub, then the symbol will disappear. → <i>Page 46</i></li> <li>■ Switching the drum clean information signal on/off. → <i>"Appliance settings" on page 40</i></li> </ul> | <p>8,0 (5,0**) kg/5,0 kg</p> <p>* - 90 °C</p> <p>400 - 1400 rpm</p> <p> (Prewash),  (Easy Iron),  (Speed Perfect)</p> <p> (Drying Aim) ✓ (* ✓,  ✓,  ✓)</p> <p>possible</p> |
| <p>* Depending on the model and the programme.</p> <p>** Reduced load with  (<b>Speed Perfect</b>) additional programme setting.</p>  |   |



| Programme/Type of laundry   | Options/Information  |
|---|--|
| <p><b>Eco 40-60</b></p> <p>Suitable for washing normally soiled cotton, linen and mixed fabric textiles, and drying it to be immediately stored in a cupboard.</p> <p><b>Notes</b></p> <ul style="list-style-type: none"> <li>Textiles which are washable based on the laundry symbol from 40°C  up to 60°C  can be washed together in the same cycle.</li> <li>The washing performance conforms to the highest possible washing performance class as defined by the legal standards. To reach the optimal energy efficiency with the best possible washing performance, the washing temperature is automatically adjusted according to the load capacity and cannot be changed.</li> <li>Wash and dry programme can be achieved by selecting <b>Eco 40-60</b> programme and activating  (<b>Drying Aim</b>).</li> </ul> | <p>8,0 kg/5,0 kg</p> <p>-</p> <p>400 - 1400 rpm</p> <p>, </p> <p> (Drying Aim) ✓ ( ✓,  ✓,  ✓)</p> <p>possible</p>  |
| <p><b>Easy Care</b></p> <p>Textiles made of synthetic materials or blended fabrics.</p>   | <p>4,0 kg/2,5 kg</p> <p> - 60 °C</p> <p>400 - 1400 rpm</p> <p>, ,  (Speed Perfect)</p> <p> (Drying Aim) ✓ ( ✓,  ✓,  ✓)</p> <p>possible</p>            |
| <p><b>Mix</b></p> <p>Mixed load of cottons and synthetic fabrics.</p>   | <p>4,0 kg/2,5 kg</p> <p> - 60 °C</p> <p>400 - 1400 rpm</p> <p>, ,  (Speed Perfect)</p> <p> (Drying Aim) ✓ ( ✓,  ✓,  ✓)</p> <p>possible</p> |
| <p><b>Sport</b></p> <p>For gentle cleaning of sports and leisure clothing made from microfibre, fleece or synthetic materials. Drying at low temperature for textile care. Select the drying targets you required.</p>  | <p>2,0 kg/2,0 kg</p> <p> - 40 °C</p> <p>400 - 800 rpm</p> <p>, </p> <p> (Drying Aim) ✓ ( ✓,  ✓,  -)</p> <p>not possible</p>   |
| <p>* Depending on the model and the programme.</p> <p>** Reduced load with  (<b>Speed Perfect</b>) additional programme setting.</p>   |  |

| Programme/Type of laundry   | Options/Information   |
|---|---|
| <p><b>Rapid 15'/ Wash &amp; Dry 60'</b></p> <p>For small amount lightly soiled garments made of cotton, linen, synthetic or blended fabrics. Approx. 15 mins for washing. If drying function is selected, it's followed by another approx. 45 mins drying process.</p> <p><b>Note:</b> The default programme is <b>Rapid 15'</b>. You can switch to <b>Wash &amp; Dry 60'</b> programme by touching  (<b>Drying Aim</b>) button.</p> | <p>2,0 kg/1,0 kg</p> <p> - 40 °C</p> <p>400 - 1000 rpm</p> <p>-</p> <p> (Drying Aim) <input checked="" type="checkbox"/> (+,  ✓,  -)</p> <p>possible</p>   |
| <p><b>Rinse</b></p> <p>For rinsing with a subsequent spin cycle.</p>  | <p>-/-</p> <p>-</p> <p> - 1400 rpm</p> <p> (Easy Iron)</p> <p> (Drying Aim) <input checked="" type="checkbox"/> (+ ✓,  ✓,  ✓)</p> <p>possible</p>     |
| <p><b>Spin/Drain</b></p> <p>For spinning with a selectable spin speed and subsequent draining. If you have selected , it will run <b>Drain</b> programme, the water is only drained after rinse process, no spin cycle.</p>  | <p>-/-</p> <p>-</p> <p> - 1400 rpm</p> <p> (Easy Iron)</p> <p> (Drying Aim) <input checked="" type="checkbox"/> (+ ✓,  ✓,  ✓)</p> <p>not possible</p> |
| <p><b>Wool/ Handwash</b> </p> <p>Hand- or appliance-washable fabrics that are made of wool or contain wool;</p> <p>particularly gentle wash programme to prevent laundry from shrinking, with longer pauses in the programme (during which the items rest in the water).</p>   | <p>2,0 kg/-</p> <p> - 40 °C</p> <p> - 800 rpm</p> <p>-</p> <p> (Drying Aim) -</p> <p>possible</p>  |
| <p><b>Delicate/Silk</b></p> <p>For delicate, washable fabrics, e.g. made of silk, satin, synthetic fibres or blends (e.g. silk blouses, silk scarves).</p>  | <p>2,0 kg/-</p> <p> - 40 °C</p> <p> - 800 rpm</p> <p> (Prewash),  (Easy Iron)</p> <p> (Drying Aim) -</p> <p>possible</p>   |
| <p>* Depending on the model and the programme.<br/>                 ** Reduced load with  (<b>Speed Perfect</b>) additional programme setting.</p>   |   |

| Programme/Type of laundry   | Options/Information   |
|---|---|
| <b>Iron Assist</b> <br>Odor removal and wrinkle reduction program, suitable for wool, linen, suits, etc. which do not need frequent washing.   | -/1,0 kg  |
| <b>Notes</b> <ul style="list-style-type: none"> <li>It is recommended to hang the clothing in a ventilated environment for 3-5mins after program finished. In case of continuously using the refresh program, it is recommended to run a washing cycle between each refresh program cycle to remove odor from the appliance.</li> <li>The detergent can not be added for this programme.</li> </ul>   | -<br>-<br>-<br>-<br>☀ (Drying Aim) -<br>not possible  |
| <b>My Time Dry</b><br>Mixed fabrics; for lightly soiled laundry made of cotton and synthetics.<br>The length of the programme can be set each time from the minimum 20 minutes. The maximum programme length is 120 minutes, it can be reduced in 10-minute increments.   | -/5,0 kg  |
| <b>Notes</b> <ul style="list-style-type: none"> <li>The ☺ (<b>Finish in/Time Dry</b>) programme default setting can not be selected for this programme.</li> <li>This programme is only used for drying process, the detergent can not be added.</li> <li>It is recommended to use automatic drying function to get better drying result and save energy.</li> </ul>  | -<br>-<br>-<br>-<br>☀ (Drying Aim) -<br>not possible  |
| <b>Gentle Dry</b><br>Single gentle dry programme for drying garments with lower temperature,<br>- by selecting  + to achieve automatic cupboard+ dry result,<br>- by selecting  to achieve automatic cupboard dry result,<br>- by selecting  to achieve automatic iron dry result.      | -/2,5 kg  |
|   | -<br>-<br>-<br>-<br>☀ (Drying Aim) ✓ (  + ✓,  ✓,  ✓) |
|   | not possible  |
| <b>Intensive Dry</b><br>Single normal dry program for drying garments with higher temperature,<br>- by selecting  + to achieve automatic cupboard+ dry result,<br>- by selecting  to achieve automatic cupboard dry result,<br>- by selecting  to achieve automatic iron dry result. | -/5,0 kg  |
|   | -<br>-<br>-<br>-<br>☀ (Drying Aim) ✓ (  + ✓,  ✓,  ✓) |
|   | not possible  |
| * Depending on the model and the programme.<br>** Reduced load with  ( <b>Speed Perfect</b> ) additional programme setting.  |   |



## Drying table

| Recommended drying programme | Drying load (kg) | Estimated drying time (min)  |   |  |
|------------------------------|------------------|--|---|--|
|                              |                  |  (Iron-Dry) |  (CupboardDry) |  (CupboardDry+) |
| Intensive Dry                | 0.5-2.0          | 40-70  | 40-90   | 60-100   |
|                              | 2.0-3.0          | 70-90  | 90-120  | 100-130  |
|                              | 3.0-5.0          | 90-130   | 120-210   | 130-240  |
| Gentle Dry                   | 0.5-1.5          | 20-50  | 30-60   | 70-120   |
|                              | 1.5-2.5          | 50-80  | 60-110  | 120-160  |

- i Drying time table is only for reference. For wash + dry program, washing duration shall be added for total program time.
- i The time listed above is the reference value, the actual drying effect may be affected by the clothing type, clothing weight, dehydration degree and ambient temperature.
- i In order to achieve uniform drying effect, it is recommended to distinguish between heavy and light-weight clothing. For example, separate the thick towel and the shirt to dry.
- i  (CupboardDry+) is recommended for drying bulky or heavy clothing.
- i In order to reduce the folding of clothing after drying, it is recommended to put a small amount of clothing drying.
- i Please refer to the panel display for the drying time of the programme not mentioned in the table above.

## **P+** Programme default settings

You can change the default settings for selected programmes. The settings can be changed even while the selected programme is running. The effects depending on the progress of the programme.

### (Temperature)

Before and after the programme starts, you can change the temperature setting, depending on what stage the programme is in, by adjusting the desired temperature on the display.

The maximum temperature that can be set depends on the programme that has been selected.

### (Spin Speed Reduction)

Depending on what stage the programme is in, you can change the spin speed (in rpm; revolutions per minute) before and during the programme by adjusting the desired speed on the display.

**setting**  = "No spin". The rinsing water is drained but there is no final spin. The laundry stays wet inside the drum, e.g. for items that should not be spun.



You can select "No spin" to prevent creasing if the laundry will not be taken out of the appliance immediately after the programme has ended.

The maximum speed that can be set depending on the model and the programme that has been selected.

### (Finish in/Time Dry)



**Before starting the programme**, you can preselect the programme end ("Finish in" time) in 0.5h (h = hour) increments (between "minimum selectable ending time" and 9.5h) or 1 hour increments (between 10h and 24h) up to a maximum of 24 hours.

To do this:

1. Select a programme (except **My Time Dry\*** programme).  
The programme duration is displayed for the selected programme, e.g. **2:30** (hours:minutes).
2. Select the  (**Finish in/Time Dry**) button repeatedly until the required number of hours is displayed.
3. Select the  (**Start/Reload/Pause**) button.  
The programme starts.  
The selected number of hours (e.g. **8h**) is shown in the display panel and counts down until the programme starts. The duration of the programme is then displayed.

**Note:** The length of the programme is automatically adjusted when the programme is running. Changes to the programme default settings or additional programme settings may also change the programme duration.

**After starting the programme** (if a "Finish in" time has been selected and the programme has not yet started), you can change the preselected number of hours as follows:

1. Select the  (**Start/Reload/Pause**) button.
2. Select the  (**Finish in/Time Dry**) button repeatedly to change the number of hours.
3. Select the  (**Start/Reload/Pause**) button.

\* Depending on the model

## **P+** Additional programme settings

**Note:** You can find possible additional programme settings in the overview; these differ depending on the model.

By selecting additional programme settings, you can better adapt the washing/drying process to your items of laundry.

The settings can be selected or deselected depending on the progress of the programme.

The button indicator lamps light up if a setting is activated.

The settings are not retained after the appliance is switched off.

### (Drying Aim)

Touch  (**Drying Aim**) to activate or deactivate the drying function. Washing and drying without interruption is possible when the function is activated (only for **Optional drying** programmes). There are three drying target mode can be selected as desired:

 (**CupboardDry**): For single-layer fabrics. Garments can be folded or hung up in a cupboard. It is the standard drying target mode. In this mode the drying time is automatically set according to the amount of laundry to be dried.

 (**CupboardDry+**): For fabrics made of thick, multilayered items of clothing, which need to be dried longer. Garments can be folded or hung up in a cupboard. Laundry more dry than Cupboard dry.

 (**IronDry**): For delicate laundry. Fabrics suitable for ironing (iron fabrics in order to avoid creasing). Garments can be additionally hung up to dry.

The drying process would proceed followed washing process when the  (**Drying Aim**) activated. If you only need the individual drying programme, you can select **Intensive Dry**, **Gentle Dry** or **My Time Dry**.

### Notes

- Do not exceed the maximum loads for drying.  
Overview of programmes  
→ "Selectable programme"  
on page 29
- Maximum spin speed for programme with drying phase will be selected automatically to obtain a good drying result.

### (Prewash)

Prewash for heavily soiled laundry.

Touch  (**Prewash**) to activate or deactivate it.

**Note:** Put the detergent into dispenser **I** and **II**.

### (Easy Iron)

A special operation using reduced spin speed followed by fluffing to help reduce creasing.

Touch  (**Easy Iron**) to activate or deactivate it.

**Note:** If  (**Easy Iron**) has been activated, the laundry will have retained a higher than average level of moisture after spinning.

### (Speed Perfect)

Washing in a shorter time while achieving a washing result that is consistent with the normal performance.

Touch  (**Speed Perfect**) to activate or deactivate this additional programme setting.

**Note:** With the  (**Speed Perfect**) additional programme setting activated, the maximum load of washing will be reduced, and extra water will be needed for the washing process.



## Operating the appliance

### Preparing the appliance

The appliance was tested before delivery. To remove residual water from the test procedure, the first wash cycle should be run without laundry using the **Cotton 90°C** programme.

→ "Before washing for the first time" on page 19

#### Notes

- Never switch on a damaged appliance!
- Inform customer service!

#### 1. Insert mains plug.



#### **Warning**

#### **Risk of death from electric shock!**

Risk of death if live parts are touched.

- Never pull out the mains plug by tugging the power cord.
  - Insert/pull out the mains plug with dry hands only.
- #### 2. Turn the water tap on.

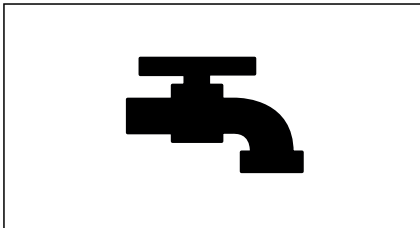

#### 3. Open the appliance door.

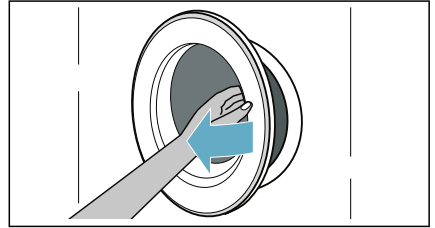

### Select programme/switch on the appliance

**Note:** If you have activated the childproof lock, you must first deactivate it before you can set a programme.

Use the programme selector to select the required programme. The programme selector can be rotated in either direction.

The appliance is switched on.

The **programme default settings** for the selected programme alternately appear in the display panel:

- The maximum load and
- the duration of the programme and
- ...

### Placing laundry into the drum

Open the door, place laundry in the drum, make sure that no items of laundry are trapped between the door and the rubber seal, and close the door.

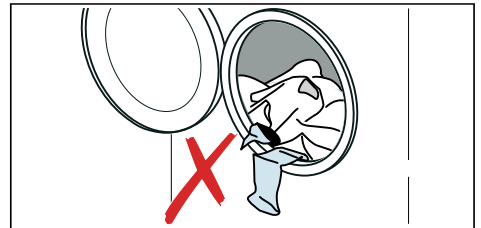

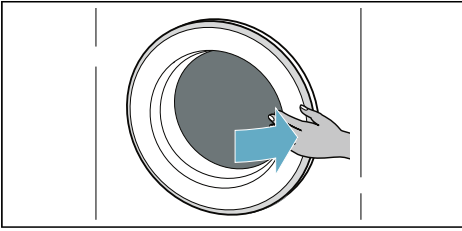

**Notes**

- Unfold and load presorted items of laundry. Mix large and small items. Washing items of different size distribute themselves better during the spin cycle. Individual items of washing may cause an unbalanced load.
- Observe the maximum specified load. Overfilling adversely affects the washing/drying result and promotes creasing.

**Dosing and adding detergent and care products**

**Caution!**

**Damage to the appliance**

Detergents and agents for the pretreatment of laundry (e.g. stain remover, prewash sprays, etc.) may damage the surfaces of the appliance. Keep these agents away from the surfaces of the appliance. Using a damp cloth, immediately remove any fine spray residue and other residue/droplets.

**Dosing**

Dose the detergents and care products according to:

- water hardness (ask your water supply company),
- the manufacturer's specifications on the packaging,
- the amount of laundry,
- soiling.

**Filling the dispensers**

1. Pull out the detergent drawer.

**⚠ Warning**  
**Eye / skin irritation!**

If the detergent drawer is opened while the appliance is running, detergent/care product may run out. Carefully open the drawer.

If detergent/care product comes into contact with eyes or skin, rinse thoroughly.

If accidentally swallowed, seek medical advice.

2. Pour in detergent and/or cleaning product.

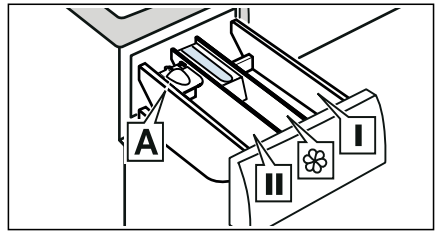

|                     |  |
|---------------------|--|
| Dispenser <b>I</b>  | Detergent for pretreat and clothing disinfectant. (only for the appliance with pretreat and disinfectant function) |
| Dispenser           | Softener, starch. Do not exceed the maximum load.  |
| Dispenser <b>II</b> | Detergent for main wash, water softener, bleach, stain remover.  |
| Dispenser <b>A*</b> | For dosing liquid detergent.   |

\*depending on the model

**Notes**

- Always follow the manufacturer's instructions when dosing all detergents, cleaning aids, care products and cleaning agents.
- Dilute viscous fabric softener and fabric conditioner with water. This will prevent blockages.

- Be careful when opening the detergent drawer while the appliance is running.

### Measuring aid A\* for liquid detergent

\*depending on the model

Position the measuring aid A for measuring the correct amount of liquid detergent:

1. Pull out the detergent drawer. Press down the insert and fully remove the drawer.

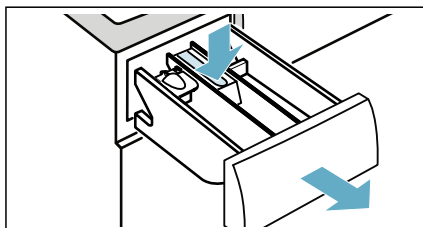

2. Slide the measuring aid forwards, fold it down and click it into place.

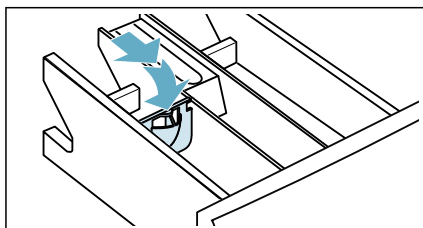

3. Reinsert the drawer.

**Note:** Do not use the measuring aid for gel detergents and washing powder, or for programmes with pretreat or when "Finish in" time is selected.

**For models without a measuring aid,** pour the liquid detergent into the appropriate dispenser and place it in the drum.

## Starting the programme

Touch and hold  (**Start/Reload/Pause**) button for 1~2 seconds, then release the button. The programme starts and the appliance door is locked.



The finish-in time is shown in the display panel and counts down until the programme starts. After the programme has started, the programme duration is displayed. And the symbols for the programme progress are lighting up.

## Childproof lock

You can lock the appliance to prevent the settings you have set from being changed inadvertently. To do this, activate the childproof lock.



To activate the childproof lock:

After the programme starts, Touch and hold the  (**SpeedPerfect**) and  (**Finish in/Time Dry**) buttons for 3 seconds. The symbol  lights up in the display panel.

-  lights up: The childproof lock is activated.
-  flashes: If the programme and programme settings are adjusted while childproof lock is activated.

**Note:** When the programme ends, *End* is displayed. The door is unlocked.  symbol remain on to remind you to deactivate the childproof lock.

To deactivate the childproof lock:



Touch and hold the  (**SpeedPerfect**) and  (**Finish in/Time Dry**) buttons until the symbol  disappears.

## Adding/removing laundry

After starting the programme (only for washing), you can add or remove laundry if necessary.

Touch the  (**Start/Reload/Pause**) button. The appliance checks whether reloading is possible.

If the following appears on the display panel:

- The symbol  disappears, reloading is possible.
- The symbol  lights up, reloading is not possible.

**To continue the programme, touch the  (**Start/Reload/Pause**) button.** The programme continues automatically.

### Notes

- Do not leave the door open for too long when adding laundry as water from the laundry may leak out.
- For safety reasons, the door remains locked when the water level or temperature is high, or while the drum is turning, and it is not possible to add laundry during this time.

## Changing the programme



If you have started the wrong programme by mistake, you can change the programme as follows:

1. Touch the  (**Start/Reload/Pause**) button.
2. Select another programme.
3. And touch the  (**Start/Reload/Pause**) button again. The new programme starts from the beginning.



**Note:** If drying is activated, you can change the programme by programme selector directly.

## Cancel the programme

For programmes washing at high temperatures:

1. Touch the  (**Start/Reload/Pause**) button.
2. To cool down laundry: Select **Rinse**.
3. Touch the  (**Start/Reload/Pause**) button.



For programmes washing at low temperatures:

1. Touch the  (**Start/Reload/Pause**) button.
2. Select **Spin/Drain**.
3. Touch the  (**Start/Reload/Pause**) button.

For programmes in drying process:

1. Turn the programme selector to any other programme.
2. Wait a few minutes to cool down laundry, then the door will be unlocked.

## Programme end

**End** lights up on the display and  and  displays are off.

If you have selected , the water is only drained after rinse process, no spin cycle.

### Notes

- If **Hot** flashes in the display before the drying programme ends, the temperature in the drum is high. The programme for cooling the drum runs until the temperature in the drum has dropped.

- If you do not take laundry out within 15 mins after drying process finished, wrinkle guard process will start to prevent laundry getting wrinkled. The process lasts about 30 minutes. **0:00**, **ERR**, **Lo** and **End** will be displayed alternately on the display and ☺ symbol will be displayed as the status symbol. You can touch any button to terminate this process, then the door will be released and laundry can be taken out.

## Removing laundry/switching off the appliance

1. Set programme selector to **Av (Off)**.
2. Open the door and remove the laundry.
3. Turn off the water tap.

**Note:** Not required for Aqua-Stop models.

### Notes

- Do not leave any items of laundry in the drum. They may shrink in the next wash or discolour another item.
- Remove any foreign objects from the drum and the rubber seal – risk of rusting.
- Wipe the rubber seal dry.

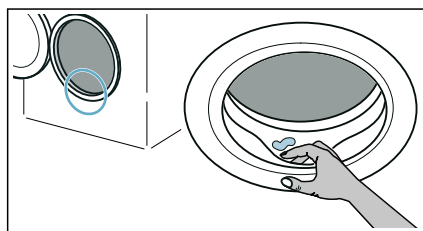

- Leave the door and detergent drawer open so that any residual water can evaporate.
- Always wait until the programme ends, as the appliance could still be locked. Then switch the appliance on and wait for it to unlock.

## Appliance settings

You can change the following settings:

- The volume of the end signal.
- The volume of the button signal.
- Switching the drum care information signal on/off.

You will need to activate the setting mode in order to change these settings.

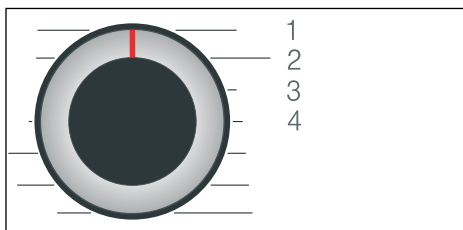

1/2/3/4... positions on the programme selector

### Activate setting mode:

1. Set the programme selector to position 1. The appliance is switched on.
2. Touch and hold the ☺ (**Spin Speed Reduction**) button and, at the same time, turn the programme selector clockwise to position 2. Release the ☺ (**Spin Speed Reduction**) button.

The setting mode is activated and the preset setting appears in the display panel.

### Changing the volume and drum care information

Use the ☺ (**Finish in/Time Dry**) button to change the following settings at the corresponding programme selector positions:

- 2: The volume of the end signal.



- 3: The volume of the button signals.



0 = off, 1 = quiet,  
2 = medium, 3 = loud,  
4 = very loud

- 4: Switching the drum care information signal on/off.

**On** on  
**OFF** off

### Exiting setting mode

You can now end the process and set the programme selector to the **Av (Off)** position. The settings are saved.



## Sensors

### Unbalanced load detection system

The automatic unbalanced load detection system detects imbalances and ensures even distribution of the laundry by repeatedly starting and stopping drum spinning.

If the laundry is extremely unevenly distributed, the spin speed is reduced or the spin cycle is not performed for safety reasons.

**Note:** Place large and small items of laundry evenly in the drum.



## Cleaning and maintenance

### Warning

#### Risk of death!

There is a risk of electric shock if touch live components.

Turn the programme selector to **Av (Off)**. Pull out the mains plug.

### Caution!

#### Fire and explosion hazard!

Toxic vapours can be produced by cleaning agents that contain solvents, e.g. cleaning solvent.

Do not use cleaning agents that contain solvents.

### Caution!

#### The appliance may be damaged!

Cleaning agents that contain solvents, e.g. cleaning solvent, can damage surfaces and components in the appliance.

Do not use cleaning agents that contain solvents.

### Appliance housing/control panel

- Remove the detergent residue immediately.
- Wipe the housing and the control panel with a soft, damp cloth.
- Do not use abrasive cloths, sponges or detergents (stainless steel cleaner).
- Do not clean the appliance with a water jet.

## Drum

### Warning

#### **Risk of injury/material damage/ damage to the appliance!**

Permanently washing at low temperatures and a lack of ventilation for the appliance may damage the drum and cause injury.

Regularly run a programme for cleaning the drum or wash at temperatures of at least 60°C.

Leave the appliance to dry after every operation with the door open, and leave the detergent drawer to dry.

Use chlorine-free cleaning agents, do not use steel wool.

If there are odours in the appliance, or to clean the drum, run the **Cotton 90°C** programme without laundry.

## Descaling

Descaling should not be necessary if the detergent is measured out correctly. However, if it is required, follow the manufacturer's instructions for the descaling agent. Suitable descalers can be obtained via our website or from customer services.

## Emptying the detergent draw, cleaning the detergent drawer and its housing

If the appliance contains detergent or fabric softener residues:

1. Pull out the detergent drawer. Press down the insert and fully remove the drawer.

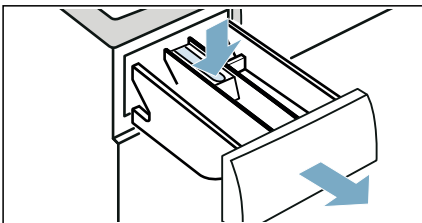

2. To remove the insert: Push the insert upwards from below with your finger.

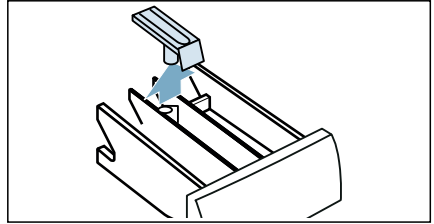

3. Clean the detergent dispenser tray and insert with water and a brush, and dry it. Clean the inside of the housing as well.

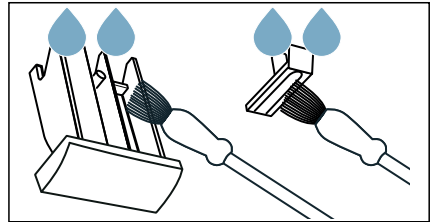

4. Fit the insert and lock it in place (push the cylinder onto the guide pin).

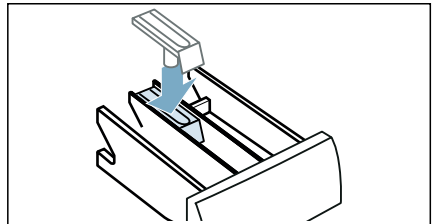

5. Push in the detergent drawer.

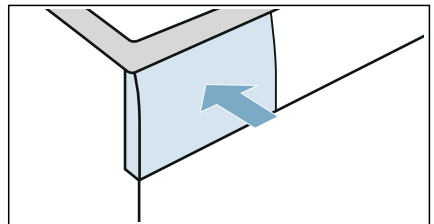

**Note:** Leave the detergent drawer open so that any residual water can evaporate.

## Drain pump is blocked

**Note:** Turn the water tap off to prevent more water from flowing in and to ensure that it is drained via the pump.

**⚠ Warning**  
**Risk of scalding!**

When you wash at high temperatures, the water gets very hot. If you come into contact with the hot water, you may be scalded.

Allow the water to cool down first.

1. Turn the programme selector to **Av (Off)**. Pull out the mains plug.
2. Open the service flap.

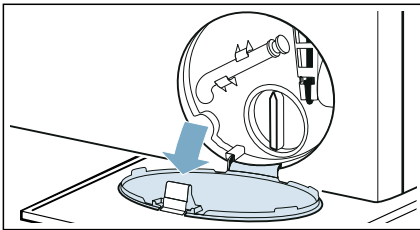

3. Take the drain hose out of the retainer. Remove the sealing cap and pour the water out into a suitable container. Replace the sealing cap and place the drain hose back in the retainer.

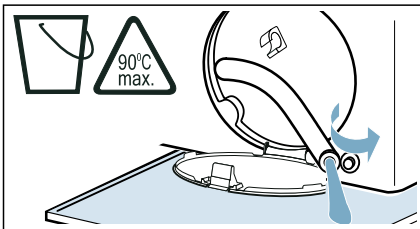

4. Carefully unscrew the pump cover; residual water may leak out. Clean the interior, pump cover thread and pump housing. The impeller in the drain pump must be able to rotate.

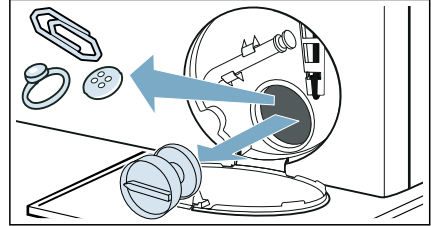

5. Refit and screw on the pump cover. The handle must be in a vertical position.

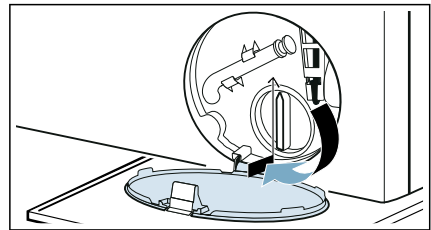

6. Close the service flap.

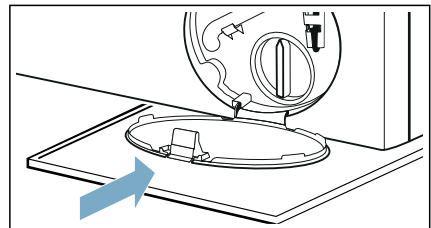

**Note:** To prevent unused detergent from flowing straight into the drain during the next wash: Pour 1 litre of water into dispenser II and start the **Drain** programme.

## The drain hose at the siphon is blocked

1. Turn the programme selector to **Av (Off)**. Pull out the mains plug.
2. Loosen the hose clamp. Carefully remove the drain hose; residual water may leak out.
3. Clean the drain hose and siphon connecting piece.

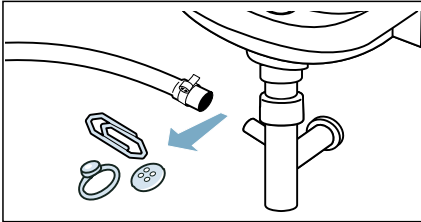

4. Re-attach the drain hose and secure the connection point using the hose clamp.

## Filter in the water supply is blocked

### Release water pressure in the supply hose:

1. Turn off the water tap.
2. Select any programme (except **Rinse, Spin, Drain** programmes).
3. Select the **▷||| (Start/Reload/Pause)** button. Allow the programme to run for approx. 40 seconds.
4. Turn the programme selector to **Av (Off)**.
5. Pull out the mains plug.

### Clean the filters:

1. Disconnect the hose from the rear of the appliance.

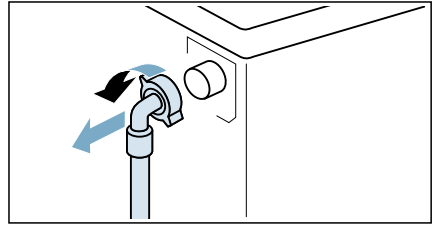

2. Use pliers to remove the filter.

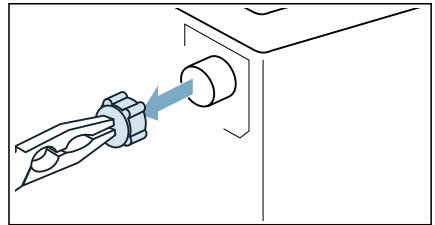

3. Clean the filter with a small brush.

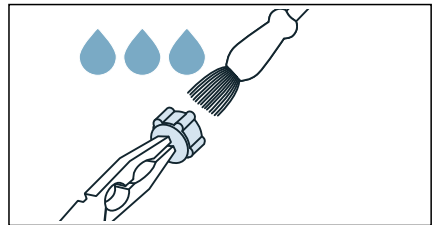

4. Connect the hose and check for leaks.

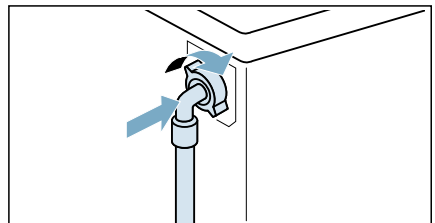

## **Faults and what to do about them**

### **Emergency release**

E.g. power outage or in the event of a loss of power

The programme continues when the power supply is restored.

However, if the laundry has to be removed, the appliance door can be opened as follows:

#### **Warning**

##### **Risk of scalding!**

When you are washing at high temperatures, there is a risk of scalding if you come into contact with hot water and laundry.

If possible, leave it to cool down first.

#### **Warning**

##### **Risk of injury!**

Reaching into the drum while it is still turning may cause hand injuries. Do not reach into the drum when it is turning.

Wait until the drum has stopped turning.

#### **Caution!** **Water damage!**

Any escaping water may cause water damage.

Do not open the door if water can be seen through the glass.



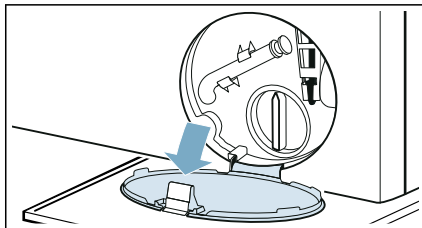

1. Turn the programme selector to **Av (Off)**. Pull out the mains plug.
2. Open the service flap.

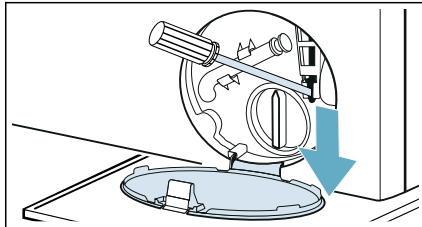

3. Drain the water. → *Page 43*
4. Pull the emergency release downwards with a tool and release. The door can then be opened.





## Information on the display panel

| Display  | Cause/Remedy   |
|--|--|
|                      | <ul style="list-style-type: none"> <li>■ <b>Flashes fast + signal:</b> The door was opened and the water level is too high. Close the door, continue the programme with  (<b>Start/Reload/Pause</b>) button or select <b>Drain</b>.</li> <li>■ <b>Flashes slowly:</b> The door lock temperature is too high to open the door. Wait approx. 30 seconds until the door lock temperature cools down.</li> </ul>  |
| <b>Hot</b>   | The temperature in the drum is too high. Wait for the appliance running to cool down the laundry till the <b>Hot</b> disappears on the display panel, then the door can be opened.   |
|                      | <ul style="list-style-type: none"> <li>■ <b>Flashes</b> (no water supply): Water tap turned on? Filter in the water supply is blocked? → <i>"Filter in the water supply is blocked" on page 44</i><br/>Is the supply hose kinked or trapped?</li> <li>■ <b>Lights up</b> (low water pressure): For information only. This will not affect the programme progress. The programme duration is extended.</li> </ul>   |
|  lights up           | The childproof lock is activated – deactivate it.  |
| The symbol  flashes | Run the <b>Cotton 90°C</b> programme to clean and care for the drum and the outer tub.<br><b>Notes</b> <ul style="list-style-type: none"> <li>■ Run the programme without laundry.</li> <li>■ Use washing powder or a detergent containing bleach. To prevent foaming, only use half the amount of detergent recommended by the detergent manufacturer. Do not use detergent designed for woollens or delicates.</li> <li>■ Switching the drum care information signal on/off. → <i>Page 40</i></li> </ul>   |
| <b>E:36</b><br>alternating with<br><b>-10</b>  | <ul style="list-style-type: none"> <li>■ Drain pipe or water drain hose is blocked. Clean the drain pipe and the water outlet hose.</li> <li>■ Drain pipe or water drain hose is caught or jammed. Ensure that the drain pipe and water drain hose are not kinked or trapped.</li> <li>■ The drain pump is blocked.<br/>→ <i>"Drain pump is blocked" on page 43</i></li> <li>■ The drain hose at the siphon is blocked.<br/>→ <i>"The drain hose at the siphon is blocked" on page 44</i></li> <li>■ The water drain hose is connected too high. Install the water outlet hose at a maximum height of 1 meter.<br/>→ <i>Page 16</i></li> </ul> |
| <b>E:35</b><br>alternating with<br><b>-10</b> (Suitable for special models)                          | There is water in the base trough, the appliance is leaking. Turn off the tap. Call customer services.   |
| <b>H:95</b><br>alternating with<br><b>End</b><br>when programme is finished                          | No water detected in drying phase, may get bad drying result.<br>→ <i>"Filter in the water supply is blocked" on page 44</i>   |

| Display  | Cause/Remedy   |
|--|--|
| <b>H:32</b><br>alternating with <b>End</b><br>when programme is finished | The unbalanced load detection system has interrupted the spin cycle because the laundry is unevenly distributed. Distribute small and large items of laundry evenly in the drum. |
| Other displays   | Turn the programme selector to <b>Av (Off)</b> , wait for five seconds and then switch it on again. If the display appears again, call customer services.                        |

## Faults and what to do about them

| Faults  | Cause/Remedy   |
|---|--|
| Water is leaking from the appliance.  | <ul style="list-style-type: none"> <li>■ Attach the drain hose correctly or replace it.</li> <li>■ Tighten the screw fitting on the supply hose.</li> </ul>  |
| The door cannot be opened.  | <ul style="list-style-type: none"> <li>■ <b>----</b> (Rinse hold = no final drain) is activated (depending on the module). Continue the programme by selecting <b>Spin/Drain</b> and pressing <b>▷∞</b> (<b>Start/Reload/Pause</b>).</li> <li>■ The temperature in drum is too high to open the door.</li> <li>■ The safety function is activated. Stop the programme?</li> <li>■ The water level in drum is too high.</li> <li>■ Can the door only be opened by the emergency release?<br/>→ "Emergency release" on page 45</li> </ul>  |
| The appliance is not filling with water.<br>Detergent is not being dispensed. | <ul style="list-style-type: none"> <li>■ Programme does not start?</li> <li>■ Is the tap turned on?</li> <li>■ Could the filter in the water supply be blocked?<br/>→ "Filter in the water supply is blocked" on page 44</li> </ul> <p><b>Note:</b> If an additional water filter has been installed (depending on the model), check for contaminants and clean if required → separate installation and cleaning instruction for water filter.</p> <ul style="list-style-type: none"> <li>■ Is the supply hose kinked or trapped?</li> </ul>   |
| The programme will not start.   | <ul style="list-style-type: none"> <li>■ Have you touched the <b>▷∞</b> (<b>Start/Reload/Pause</b>) button or selected <b>☺</b> (<b>Finish in/Time Dry</b>)?</li> <li>■ Is the door closed?</li> <li>■ Childproof lock activated? Deactivate childproof lock.</li> <li>■ Shop mode activated? If the display shows <b>SHD</b> for 5 s after you have switched on the appliance, the appliance is in shop mode. Wait for the display message <b>SHD</b> to disappear. Touch and hold <b>▷∞</b> (Start/Reload/Pause) for at least 5 s. <b>OFF</b> will appear in the display panel. Turn the programme selector to <b>Av (Off)</b>. Now you already turned off the shop mode. You can use the appliance now as usual.</li> </ul> |

| Faults   | Cause/Remedy  |
|--|---|
| The water is not draining.   | <ul style="list-style-type: none"> <li>■ Drain pipe or water drain hose is blocked. Clean the drain pipe and the water drain hose.</li> <li>■ Drain pipe or water drain hose is caught or jammed. Ensure that the drain pipe and the water drain hose are not kinked or trapped.</li> <li>■ The drain pump is blocked.<br/>→ "Drain pump is blocked" on page 43</li> <li>■ The drain hose at the siphon is blocked.<br/>→ "The drain hose at the siphon is blocked" on page 44</li> <li>■ — — — (Rinse hold = no final drain) is activated (depending on the model). Continue the programme by selecting <b>Spin/Drain</b> and pressing  (<b>Start/Reload/Pause</b>).</li> <li>■ The water drain hose is connected too high. Install the water drain hose at a maximum height of 1 meter.<br/>→ "Hose and cable lengths" on page 16</li> </ul> |
| Water is not visible in the drum.  | Not a fault – the water is below the visible area.  |
| The wrong detergent/fabric softener has been poured into the dispenser(s).                 | <p>Empty the dispenser(s), clean it/them and pour in the correct product.<br/>→ "Emptying the detergent draw, cleaning the detergent drawer and its housing" on page 42</p> <p>→ "Dosing and adding detergent and care products" on page 37</p>   |
| Detergent/fabric softener has congealed in the dispensers.                                 | <p>Empty the dispenser(s), clean it/them and pour in the correct product.<br/>→ "Emptying the detergent draw, cleaning the detergent drawer and its housing" on page 42</p> <p>→ "Dosing and adding detergent and care products" on page 37</p>   |
| Foam is leaking from the detergent drawer.   | <p>Too much detergent used?</p> <p>Mix 1 tablespoon of fabric softener with ½ litre of water and pour into dispenser <b>II</b>. (Not for outdoor, sports and down-filled textiles!)</p> <p>Reduce detergent dosage for the next wash cycle.</p> <p>Use commercially available low foam detergent and care product which are suitable for machine.</p>   |
| Repeated, intensive foaming.   | Have you used too much detergent? Add less detergent in the next time you run a wash cycle with the same load.  |
| Detergent/fabric softener drips off the seal and collects on the door or in the seal fold. | There is too much detergent/fabric softener in the dispensers. Do not fill the dispensers above the <b>max.</b> mark.   |
| The spin result is not satisfactory.<br>Laundry wet/too damp.                              | <ul style="list-style-type: none"> <li>■ Not a fault – the unbalanced load detection system has interrupted the spin cycle because the laundry is unevenly distributed. Distribute small and large items of laundry evenly in the drum.</li> <li>■ Is  (<b>Easy Iron</b>) additional programme setting selected (depending on the model)?</li> <li>■ Is <b>Silent</b> additional programme setting or <b>Silent</b> programme selected (depending on the model)?</li> <li>■ Is the selected speed too low?</li> </ul>  |



| Faults   | Cause/Remedy  |
|--|---|
| The spin cycle runs several times.   | Not a fault – the unbalanced load detection system is adjusting an imbalance.   |
| The programme is taking longer than usual.                                     | <ul style="list-style-type: none"> <li>■ Not a fault – the unbalanced load detection system is adjusting an imbalance by repeatedly distributing the laundry.</li> <li>■ Not a fault – the foam detection system is activated – a rinse cycle has been switched on.</li> </ul>  |
| The length of the programme changes during the wash cycle.                     | Not a fault – the programme sequence is optimised for the specific washing process. This may change the length of the programme shown on the display panel.   |
| Odours, stain formation in the appliance.                                      | <p>Run the <b>Cotton 90°C</b> programme without laundry.</p> <p>Add washing powder or a detergent containing bleach.</p> <p><b>Note:</b> To prevent foaming, only use half the amount of detergent recommended by the detergent manufacturer. Do not use detergents designed for woollens or delicates.</p>   |
| Loud noises, vibrations and appliance "movement" during the spin cycle.        | <ul style="list-style-type: none"> <li>■ Is the appliance aligned? → <i>"Alignment" on page 18</i></li> <li>■ Are the appliance's feet fixed? Secure the appliance's feet.</li> <li>■ Have the transport locks been removed? → <i>"Removing the transport locks" on page 14</i></li> </ul>  |
| The display panel indicator lights do not work while the appliance is running. | <ul style="list-style-type: none"> <li>■ Has there been a power failure?</li> <li>■ Have the fuses blown? Reset/replace the fuses.</li> <li>■ If the fault occurs repeatedly, call customer services.</li> </ul>  |
| There is detergent residue on the laundry.                                     | <ul style="list-style-type: none"> <li>■ Some phosphate-free detergents contain water-insoluble residue.</li> <li>■ Select <b>Rinse</b> or brush the laundry after washing.</li> </ul>  |
| Spin noise during the drying phase.  | This is an innovative process known as thermal spinning used to reduce energy consumption during the drying phase. It is designed like this, please wait until programme finished.  |
| Fluff found on the laundry.  | Run the <b>Cotton *</b> (cold) programme without laundry and detergent to remove fluff which have accumulated inside the drum during the previous drying cycle.   |
| Water inlet noise during the drying phase.                                     | The washer dryer uses water condensation technology, water is constantly needed to dry the laundry. Therefore the water tap must be on all the time, till the end of the drying phase.  |
| Drying duration extended.  | <ul style="list-style-type: none"> <li>■ Run the <b>Cotton *</b> (cold) programme to remove fluff which has collected in the washer drum during the drying phase.</li> <li>■ If the ambient temperature is higher than 30 °C, this may extend the drying time.</li> <li>■ Insufficient air circulation in the room may increase the drying time. Ventilate the room.</li> </ul> |
| Drying programme does not start.   | <ul style="list-style-type: none"> <li>■ Drying additional programme setting not selected?</li> <li>■ Door not closed properly?</li> </ul>  |

| Faults   | Cause/Remedy   |
|--|--|
| Creasing.  | <ul style="list-style-type: none"> <li>■ Creasing occurs when you have exceeded the maximum load or selected the wrong program for the type of fabric. All the required information can be found in the programme overview table.</li> <li>■ Remove clothes immediately after drying; creasing may occur if they are left in the drum.</li> </ul>  |
| The drying result is not satisfactory (laundry is not dry enough).   | <ul style="list-style-type: none"> <li>■ After the end of the programme, warm laundry feels damper than it actually is. Spread the laundry out and allow the heat to disperse.</li> <li>■ Excessively high ambient temperature (above 30 °C) or inadequate ventilation in the room in which the washer dryer is situated.</li> <li>■ The laundry has not been spun well enough before drying. Always set the highest selectable spin speed for the particular washing programme.</li> <li>■ Washer dryer overloaded: Observe the recommendations for the maximum load in the programme table and on the load display. Do not overload the washer dryer, as the maximum load for the drying phase is less than the maximum load for the wash cycle. Unload the washer dryer after washing with the maximum load and divide the laundry into two drying cycles.</li> <li>■ The power supply voltage is too low (below 200 V) – provide a suitable power supply.</li> <li>■ The water pressure is low. According to water condensing principle, low water pressure will cause evaporated steam to not condense properly and completely.</li> <li>■ The water tap is closed during drying. Due to the use of the water condensation technology for drying, please keep the connected water tap open during the drying process, otherwise proper drying cannot be guaranteed.</li> <li>■ Thick multilayered textiles or textiles with thick fillings dry easily on the surface, but not inside. This equalisation process may take longer.</li> </ul> |
| <p>If you cannot rectify a fault yourself (after turning the programme selector to <b>Av (Off)</b> and on again) or a repair is required:</p> <ul style="list-style-type: none"> <li>■ Turn the programme selector to <b>Av (Off)</b>. Pull out the mains plug.</li> <li>■ Turn off the tap and call customer services.</li> </ul> |  |



## Customer Service

If you have any queries on use, are unable to rectify faults on the appliance yourself or if your appliance needs to be repaired, contact Customer Service.

You can solve many problems yourself by consulting the information on eliminating faults in this instruction manual or on our website. If this is not the case, contact our Customer Service

We will always find an appropriate solution and try to avoid unnecessary visits being made by a Customer Service technician.

With any warranty claims we will make sure that your appliance is repaired by trained Customer Service technicians using original spare parts, including after the manufacturer's warranty has expired.

For safety reasons repairs to the appliance should only be carried out by trained specialist staff. The warranty claim becomes void if repairs or interventions have been carried out by persons not authorised by us for that purpose or if our appliances have been fitted with spare, supplementary or accessory parts that were not genuine parts and then resulted in a defect.

Function-relevant genuine spare parts according to the corresponding Eco-design Order can be obtained from Customer Service for a period of at least 10 years from the date on which your appliance was placed on the market within the European Economic Area.

**Note:** Under the terms of the manufacturer's warranty the use of Customer Service is free of charge.

Detailed information on the warranty period and terms of warranty in your country is available from our Customer Service, your retailer or on our website.

If you contact Customer Service, you will require the product number (E-Nr.) and the production number (FD) of your appliance.

The contact details for Customer Service can be found in the enclosed Customer Service directory or on our website.

## Product number (E-Nr.) and production number (FD)

You can find the product number (E-Nr.) and the production number (fd) on the appliance's rating plate.

Depending on the model, the rating plate is located:

- On the inside of the door
- On the inside of the maintenance flap.
- On the rear of the appliance.

Make a note of your appliance's details and the Customer Service telephone number to find them again quickly.

More information about your model can be found online at <https://energylabel.bsh-group.com> \* This web address is linked to the official EU EPREL product database. At the time of printing its web address had not yet been published. Please then follow the instructions on searching for models. The model identifier is made up of the characters before the slash in the product number (E-Nr.) on the rating plate. Alternatively you can also find the model identifier in the first line of the EU energy label.

**Trust the expertise of the manufacturer.** Contact us. By doing so, you can be sure that the repairs are carried out by trained service personnel using genuine spare parts.

\* Only applies to countries in the European Economic Area.



## Consumption values

The following information is provided in accordance with the EU-Ecodesign-Regulation. The values given for programs other than the Eco 40-60 are indicative only and were determined in accordance with the applicable standard EN60456 and EN62512.

The automatic dosing function has been deactivated for this purpose.

**Note on the comparison test: Deactivate the automatic dosing function unless this function is the object of the test.**

| Programme                             | rated capacity [kg] | energy consumption [kWh/cycle] * | water consumption [l/cycle] * | Programme duration [h:min] * | maximum temperature [°C] *<br>5min | spin speed [rpm] * | remaining moisture [%] * |
|---------------------------------------|---------------------|----------------------------------|-------------------------------|------------------------------|------------------------------------|--------------------|--------------------------|
| Eco 40-60 **                          | 8,0                 | 1,102                            | 56,0                          | 3:32                         | 46                                 | 1400               | 53                       |
| Eco 40-60 **                          | 4,0                 | 0,580                            | 43,0                          | 2:48                         | 36                                 | 1400               | 53                       |
| Eco 40-60 **                          | 2,0                 | 0,145                            | 24,0                          | 2:10                         | 23                                 | 1400               | 53                       |
| Eco 40-60 + ☀ +<br>☒ (Cupboard-Dry)** | 5,0                 | 3,850                            | 87,0                          | 7:30                         | 39                                 | -                  | -0,1                     |
| Eco 40-60 + ☀ +<br>☒ (Cupboard-Dry)** | 2,5                 | 2,040                            | 45,0                          | 5:05                         | 35                                 | -                  | -0,1                     |
| Cottons 20 °C                         | 8,0                 | 0,390                            | 90,0                          | 3:05                         | 26                                 | 1400               | 53                       |
| Cottons 40 °C                         | 8,0                 | 1,140                            | 90,0                          | 3:21                         | 42                                 | 1400               | 53                       |
| Cottons 40 °C +<br>⤵ (Prewash)        | 8,0                 | 1,170                            | 96,0                          | 3:51                         | 42                                 | 1400               | 53                       |
| Cottons 60 °C                         | 8,0                 | 1,450                            | 90,0                          | 3:17                         | 53                                 | 1400               | 53                       |
| Easy Care 40 °C                       | 4,0                 | 0,815                            | 66,5                          | 2:29                         | 43                                 | 1400               | 23                       |
| Mix 40 °C                             | 4,0                 | 0,655                            | 48,0                          | 1:00                         | 40                                 | 1400               | 48                       |
| Wool/ Handwash<br>☒ 30 °C             | 2,0                 | 0,215                            | 41,5                          | 0:41                         | 27                                 | 800                | 48                       |

\* Observed values may deviate from the indicated values due to influence of water pressure, hardness and inlet temperature, ambient temperature, type, amount and soiling of laundry, detergent used, fluctuations in power supply and selected additional functions.

\*\* Test program according to the EU-Ecodesign-Regulation and EU-Energy Label-Regulation with cold water (15°C).



## Technical data

### Dimensions:

84,8 cm x 59,8 cm x 59,0 cm  
(height x width x depth)

### Weight:

71 kg

### Mains connection:

Nominal voltage 220-240V, 50 Hz

Minimum installation protection ( $\equiv$ )10 A

Nominal power 1900-2300 W

### Water pressure:

100–1000 kPa (1–10 bar)



## Aqua-Stop warranty

### Only for appliances with Aqua-Stop

In addition to warranty claims against the vendor based on the purchase agreement and to our appliance warranty, we will provide compensation under the following conditions:

1. If water damage is caused due to a fault in our Aqua-Stop system, we will compensate domestic customers for the damage caused.
2. The liability guarantee is valid for the service life of the appliance.
3. It is a prerequisite of all warranty claims that the appliance with Aqua-Stop must have been installed and connected correctly in accordance with our instructions; this also includes a correctly fitted Aqua-Stop extension (genuine accessories). Our warranty does not cover defective feed lines or fittings leading to the Aqua-Stop connection at the tap.
4. Appliances with Aqua-Stop do not need to be supervised during operation, nor secured afterwards by turning off the tap.  
The tap only needs to be turned off if you are away from home for a long period, e.g. for several weeks' holiday.



## Thank you for buying a Bosch Home Appliance!

Register your new device on MyBosch now and profit directly from:

- **Expert tips & tricks for your appliance**
- **Warranty extension options**
- **Discounts for accessories & spare-parts**
- **Digital manual and all appliance data at hand**
- **Easy access to Bosch Home Appliances Service**

Free and easy registration – also on mobile phones:

[www.bosch-home.com/welcome](http://www.bosch-home.com/welcome)

**BOSCH**  
HOME APPLIANCES  
**SERVICE**

## Looking for help? You'll find it here.

Expert advice for your Bosch home appliances, need help with problems or a repair from Bosch experts.

Find out everything about the many ways Bosch can support you:

[www.bosch-home.com/service](http://www.bosch-home.com/service)

**Contact data of all countries are listed in the attached service directory.**

### **Robert Bosch Hausgeräte GmbH**

Carl-Wery-Straße 34

81739 München, GERMANY

[www.bosch-home.com](http://www.bosch-home.com)



**9001550912** (0012)

en