

A black and white photograph of a Siemens washing machine drum. The drum is filled with white laundry, including a patterned towel and a white cloth. The drum's interior is perforated with numerous small holes. A white detergent dispenser is visible at the top of the drum. The lighting is dramatic, highlighting the metallic texture of the drum and the folds of the fabric.

SIEMENS

Washing machine

WM6HXKE1DN

en User manual and installation instructions



Register your product on My Siemens and discover exclusive services and offers.

siemens-home.bsh-group.com/welcome

The future moving in.

Siemens Home Appliances

For further information, please refer to the Digital User Guide.



Table of contents

1 Safety	4	6 Before using for the first time ...	20
1.1 General information.....	4	6.1 Starting an empty washing cycle	20
1.2 Intended use.....	4	7 Display	21
1.3 Restriction on user group.....	4	8 Buttons	24
1.4 Safe installation	5	9 Programmes	26
1.5 Safe use	7	10 Accessories.....	30
1.6 Safe cleaning and maintenance.....	9	11 Laundry.....	30
2 Preventing material damage	10	11.1 Preparing the laundry.....	30
3 Environmental protection and saving energy.....	11	12 Detergents and care products	31
3.1 Disposing of packaging	11	13 Basic operation	31
3.2 Save energy and conserve resources.....	11	13.1 Switching on the appliance	31
3.3 Energy saving mode	12	13.2 Setting a programme	31
4 Installation and connection.....	12	13.3 Adjusting the programme settings	31
4.1 Unpacking the appliance	12	13.4 Loading laundry.....	31
4.2 Contents of package.....	12	13.5 Adding detergent and care product	32
4.3 Requirements for the installation location	13	13.6 Starting the programme	32
4.4 Removing the transit bolts	13	13.7 Soaking laundry	32
4.5 Removing the transport struts.....	15	13.8 Adding laundry	32
4.6 Connecting the appliance	15	13.9 Cancelling the programme	32
4.7 Aligning the appliance.....	16	13.10 Resuming the programme when the programme status is Rinse Hold	33
4.8 Connecting the appliance to the electricity supply.....	17	13.11 Unloading the laundry	33
5 Familiarising yourself with your appliance.....	18	13.12 Switching off the appliance.....	33
5.1 Appliance	18		
5.2 Detergent drawer.....	19		
5.3 Control panel.....	19		

14 Childproof lock.....	33	20 Transportation, storage and disposal	56
14.1 Activating the childproof lock.....	33	20.1 Removing the appliance	56
14.2 Deactivating the childproof lock.....	33	20.2 Inserting the transit bolts.....	56
15 Intelligent dosing system	34	20.3 Using the appliance again	56
15.1 Starting the programme with intelligent dosing system	34	20.4 Disposing of old appliance	57
15.2 Filling the dispensers	34	21 Customer Service.....	57
15.3 Dispenser contents	35	21.1 Product number (E-Nr.) and production number (FD).....	57
15.4 Basic dosage	35	21.2 AQUA-STOP guarantee.....	58
16 Home Connect	36	22 Consumption values	59
16.1 Connecting the appliance to a WLAN home network (Wi-Fi) with WPS function	36	23 Technical specifications.....	60
16.2 Connecting the appliance to a WLAN home network (Wi-Fi) without WPS function.....	37	24 Declaration of Conformity	60
16.3 Connecting the appliance to the Home Connect app.....	37		
16.4 Activating Wi-Fi on the appliance.....	38		
16.5 Deactivating Wi-Fi on the appliance.....	38		
16.6 Resetting the appliance network settings	38		
16.7 Remote start.....	38		
16.8 Remote diagnostics	39		
16.9 Data protection.....	39		
17 Basic settings.....	39		
18 Cleaning and servicing	39		
18.1 Cleaning the drum.....	39		
18.2 Cleaning the detergent drawer.....	40		
18.3 Cleaning the drain pump.....	41		
18.4 Cleaning the intake opening in the rubber gasket.....	44		
19 Troubleshooting.....	45		
19.1 Emergency release	56		



1 Safety

Observe the following safety instructions.

1.1 General information



- Read this instruction manual carefully.
- Keep the instruction manual and the product information safe for future reference or for the next owner.
- Do not connect the appliance if it has been damaged in transit.

1.2 Intended use

Only use this appliance:

- For washing machine-washable fabrics and hand-washable wool in accordance with the care label.
- With tap water and commercially available detergents and care products suitable for washing machines.
- In private households and in enclosed spaces in a domestic environment.
- Up to an altitude of max. 4000 m above sea level.

1.3 Restriction on user group

This appliance may be used by children aged 8 or over and by people who have reduced physical, sensory or mental abilities or inadequate experience and/or knowledge, provided that they are supervised or have been instructed on how to use the appliance safely and have understood the resulting dangers.

Children must not play with the appliance.

Cleaning and user maintenance must not be performed by children unless they are being supervised.

Keep children under the age of 3 years and pets away from the appliance.

1.4 Safe installation

Take note of the safety instructions when installing the appliance.

⚠ WARNING – Risk of electric shock!

Improper installation is dangerous.

- ▶ Connect and operate the appliance only in accordance with the specifications on the rating plate.
- ▶ Connect the appliance to a power supply with alternating current only via a properly installed socket with earthing.
- ▶ The protective conductor system of the domestic electrical installation must be properly installed. The installation must have a sufficiently large cross section.
- ▶ When using a residual current circuit breaker, only use a type with the  mark.
- ▶ Never equip the appliance with an external switching device, e.g. a timer or remote control.
- ▶ When the appliance is installed, the mains plug of the power cord must be freely accessible. If free access is not possible, an all-pole isolating switch must be installed in the permanent electrical installation according to the installation regulations.
- ▶ When installing the appliance, check that the power cable is not trapped or damaged.

If the insulation of the power cord is damaged, this is dangerous.

- ▶ Never let the power cord come into contact with hot appliance parts or heat sources.
- ▶ Never let the power cord come into contact with sharp points or edges.
- ▶ Never kink, crush or modify the power cord.

⚠ WARNING – Risk of fire!

It is dangerous to use an extended power cord and non-approved adapters.

- ▶ Do not use extension cables or multiple socket strips.
- ▶ If the power cord is too short, contact Customer Service.
- ▶ Only use adapters approved by the manufacturer.

⚠ WARNING – Risk of injury!

The high weight of the appliance may result in injury when lifted.

- ▶ Do not lift the appliance on your own.

If this appliance is not correctly installed in a washer-dryer stack, the installed appliance may fall.

- ▶ Only stack the dryer on a washing machine using the connection kit from the dryer manufacturer . No other installation method is permitted.
- ▶ Do not install the appliance in a washer-dryer stack if the dryer manufacturer does not offer a suitable connection kit.
- ▶ Do not install appliances from different manufacturers and with varying depths and widths in a washer-dryer stack.
- ▶ Do not install a washer-dryer stack on a platform; the appliances may tip over.

⚠ WARNING – Risk of suffocation!

Children may put packaging material over their heads or wrap themselves up in it and suffocate.

- ▶ Keep packaging material away from children.
- ▶ Do not let children play with packaging material.

⚠ CAUTION – Risk of injury!

The appliance may vibrate or move when in use.

- ▶ Place the appliance on a clean, even, solid surface.
 - ▶ Align the appliance using the appliance feet and a spirit level.
- If hoses and power cords have been laid incorrectly, this causes a tripping hazard.
- ▶ Lay hoses and power cords in such a way that there is no risk of tripping.

If the appliance is moved by holding onto protruding components, such as the appliance door, the parts may break off.

- ▶ Do not move the appliance by holding onto protruding parts.

⚠ CAUTION – Risk of cutting!

Touching sharp edges on the appliance may lead to cuts.

- ▶ Do not touch the sharp edges on the appliance.

- ▶ Wear protective gloves when installing and transporting the appliance.

1.5 Safe use

⚠ WARNING – Risk of electric shock!

If the appliance or the power cord is damaged, this is dangerous.

- ▶ Never operate a damaged appliance.
- ▶ Never pull on the power cord to unplug the appliance. Always unplug the appliance at the mains.
- ▶ If the appliance or the power cord is damaged, immediately unplug the power cord or switch off the fuse in the fuse box and turn off the water tap.
- ▶ Call customer services. → *Page 57*

An ingress of moisture can cause an electric shock.

- ▶ Only use the appliance in enclosed spaces.
- ▶ Never expose the appliance to intense heat or humidity.
- ▶ Do not use steam- or high-pressure cleaners, hoses or sprays to clean the appliance.

⚠ WARNING – Risk of harm to health!

Children can lock themselves in the appliance, thereby putting their lives at risk.

- ▶ Do not install the appliance behind a door as this may obstruct the appliance door or prevent it from opening.
- ▶ With redundant appliances, unplug the power cord. Then cut through the cord and damage the lock on the appliance door beyond repair so that the appliance door will no longer close.

⚠ WARNING – Risk of suffocation!

Children may breathe in or swallow small parts, causing them to suffocate.

- ▶ Keep small parts away from children.
- ▶ Do not let children play with small parts.

⚠ WARNING – Risk of poisoning!

Detergents and care products may result in poisoning if consumed.

- ▶ If accidentally swallowed, seek medical advice.
- ▶ Keep detergents and care products out of the reach of children.

⚠ WARNING – Risk of explosion!

Laundry that has been pretreated with cleaning agents that contain solvents may cause an explosion in the appliance.

- ▶ Rinse pretreated laundry thoroughly with water before washing.

⚠ CAUTION – Risk of injury!

The covering plate may break if you stand on or climb onto the appliance.

- ▶ Do not stand on or climb onto the appliance.

The appliance may tip over if you sit on or lean against the open door.

- ▶ Do not sit on or lean against the appliance door.
- ▶ Do not place any objects on the appliance door.

Reaching into the drum while it is still turning may cause hand injuries.

- ▶ Wait for the drum to come to a complete stop before reaching inside.

⚠ CAUTION – Risk of scalding!

When you wash at high temperatures, the detergent solution gets hot.

- ▶ Do not touch the hot detergent solution.

⚠ CAUTION – Risk of chemical burns!

If the detergent drawer is opened, detergent and care products may spray out from the appliance. Contact with eyes or skin may cause irritation.

- ▶ Rinse eyes and/or skin thoroughly with clean water if they come into contact with detergents or care products.
- ▶ If accidentally swallowed, seek medical advice.
- ▶ Keep detergents and care products out of the reach of children.

1.6 Safe cleaning and maintenance

Take note of the safety instructions when cleaning and performing maintenance work on the appliance.

WARNING – Risk of electric shock!

Incorrect repairs are dangerous.

- ▶ Repairs to the appliance should only be carried out by trained specialist staff.
- ▶ Only use genuine spare parts when repairing the appliance.
- ▶ If the power cord of this appliance is damaged, it must be replaced by the manufacturer, the manufacturer's Customer Service or a similarly qualified person in order to prevent any risk.

An ingress of moisture can cause an electric shock.

- ▶ Do not use steam- or high-pressure cleaners, hoses or sprays to clean the appliance.

WARNING – Risk of injury!

The use of non-original spare parts and non-original accessories is dangerous.

- ▶ Only use the manufacturer's original spare parts and original accessories.

WARNING – Risk of poisoning!

Poisonous fumes may be given off if you use cleaning agents that contain solvents.

- ▶ Do not use cleaning agents that contain solvents.

2 Preventing material damage

Follow these instructions to avoid material damage and damage to the appliance.

ATTENTION!

The functionality of the appliance may be impaired if you use the wrong quantity of fabric softener, detergent, care product or cleaning agent.

- ▶ Follow the dosage recommendations from the manufacturer.

Exceeding the maximum load capacity impairs the function of the appliance.

- ▶ Observe the maximum load capacity for each programme and do not exceed it.

→ *"Programmes", Page 26*

The appliance is secured for transportation using transit bolts. Transit bolts which have not been removed may result in material damage and damage to the appliance.

- ▶ Before starting up the appliance, remove the transit bolts completely and keep them in a safe place.
- ▶ Before transport, fit the transit bolts fully in order to prevent damage in transit.

Material damage may be caused if the water inlet hose is connected incorrectly.

- ▶ Tighten the screw connections on the water inlet until they are hand-tight.
- ▶ Ideally, connect the water inlet hose directly to the water tap, without any additional connecting elements such as adapters, extensions, valves or similar.

- ▶ Make sure that the valve housing for the water inlet hose does not come into contact with its surroundings and is not subjected to any external forces.
- ▶ Ensure that the inner diameter of the water tap is at least 17 mm.
- ▶ Make sure that the length of the thread on the connection to the water tap is at least 10 mm.

If the water pressure is too high or too low, the appliance may not be able to operate properly.

- ▶ Ensure that the water pressure in the water supply system is at least 100 kPa (1 bar) and max. 1000 kPa (10 bar).
- ▶ If the water pressure exceeds the maximum value specified, a pressure-reducing valve must be installed between the drinking water connection and the hose set of the appliance.
- ▶ Do not connect the appliance to the mixer tap of an unpressurised hot-water boiler.

Modified or damaged water hoses may result in material damage and damage to the appliance.

- ▶ Never kink, crush, modify or cut through water hoses.
- ▶ Only use the water hoses supplied with the appliance or genuine spare hoses.
- ▶ Never re-use water hoses that have been used before.

Operating the appliance using water that is dirty or too hot may lead to material damage and damage to the appliance.

- ▶ Only operate the appliance with cold mains water.

Unsuitable cleaning products may damage the surfaces of the appliance.

- ▶ Do not use harsh or abrasive detergents.

- ▶ Do not use cleaning products with a high alcohol content.
- ▶ Do not use hard scouring pads or cleaning sponges.
- ▶ Clean the appliance with nothing but water and a soft, damp cloth.
- ▶ Remove all detergent residue, spray residue or other residues immediately if they come into contact with the appliance.

3 Environmental protection and saving energy

3.1 Disposing of packaging

The packaging materials are environmentally compatible and can be recycled.

- ▶ Sort the individual components by type and dispose of them separately.

3.2 Save energy and conserve resources

If you follow these instructions, your appliance will use less electricity and less water.

Choose programmes with low temperatures and longer wash times and use maximum load capacity.

- ✓ Energy consumption and water consumption is most efficient.

Use the economy programme settings.

- ✓ If you adjust the programme settings for a programme, the display shows the expected consumption.

Add detergent based on the laundry's degree of soiling.

- ✓ For light to normal soiling, a smaller amount of detergent is sufficient. Observe the dosage recommendation from the detergent manufacturer.

Reduce the washing temperature for lightly and normally soiled laundry.

- ✓ At lower temperatures, the appliance consumes less energy. For light to normal soiling, lower temperatures than indicated on the care label are also sufficient.

Set the maximum spin speed if you want to dry the laundry in the tumble dryer afterwards.

- ✓ The drier the laundry, the shorter the programme duration when drying which, in turn, reduces energy consumption. A higher spin speed reduces the residual moisture in the laundry and increases the volume of the spin noise.

Wash the laundry without prewash.

- ✓ Washing with prewash increases the programme duration and increases energy and water consumption.

The appliance has a continuous automatic load adjustment function.

- ✓ Depending on the type of fabric and load capacity, the continuous automatic load adjustment function optimally adjusts the water consumption and programme duration.

en Installation and connection

The appliance comes with an Aqua-Sensor.

- ✓ During the rinse cycle, the Aqua-Sensor checks the degree of turbidity of the rinsing water, and adjusts the duration and number of rinse cycles accordingly.

3.3 Energy saving mode

If you do not use the appliance for an extended period, it automatically switches to energy-saving mode. Energy-saving mode ends when you use the appliance again. If you do not continue operating the appliance, it switches off.

Note: If Wi-Fi is activated, the appliance will not switch itself off automatically.

4 Installation and connection

4.1 Unpacking the appliance

ATTENTION!

Objects remaining in the drum that are not designed for operation with the appliance may cause material damage and damage to the appliance.

- ▶ Remove these objects, along with all supplied accessories, from the drum before starting the appliance.

1. Remove any packaging and protective covers completely from the appliance.
→ *"Disposing of packaging", Page 11.*
2. Check the appliance for visible damage.

3. Open the appliance door.
→ *"Basic operation", Page 31*
4. Remove any accessories from the drum.
5. Close the appliance door.

4.2 Contents of package

After unpacking all parts, check for any damage in transit and completeness of the delivery.

ATTENTION!

If the appliance is operated with incomplete or defective accessories, the appliance may not be able to operate properly, or this may result in material damage or damage to the appliance.

- ▶ Do not operate the appliance with incomplete or defective accessories.
- ▶ Replace the accessories in question before operating the appliance.
→ *"Accessories", Page 30*

Note: The appliance has been tested at the factory to check it is in working order. As a result, water stains may remain in the appliance. These marks will disappear after the first wash cycle.

The delivery consists of the following:

- Washing machine
- Accompanying documents
- Transit bolts
→ *"Removing the transit bolts", Page 13*
- Cover caps
- Connection adapter
- Elbow for securing the water outlet hose

4.3 Requirements for the installation location

⚠ WARNING

Risk of electric shock!

The appliance contains live parts. Touching live parts is dangerous.

- ▶ Do not operate the appliance without a cover cap.

⚠ WARNING

Risk of injury!

When using the appliance on a base, the appliance may tip over.

- ▶ Always secure the feet of the appliance to a base using the manufacturer's fixing brackets → *Page 30* before using the appliance for the first time.

ATTENTION!

The appliance may contain residual water. If you tilt the appliance beyond 40°, this residual water may leak out.

- ▶ Tilt the appliance carefully.

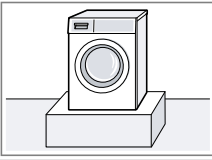
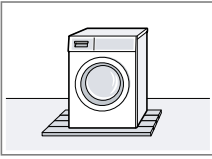
Installation location	Requirements
<p>Base</p> 	<p>Secure the appliance with fixing brackets → <i>Page 30</i>.</p>
<p>Wooden joist floor</p> 	<p>Place the appliance on a water-resistant wooden board (minimum thickness of 30 mm) which is screwed tightly to the floor.</p>

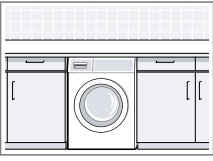
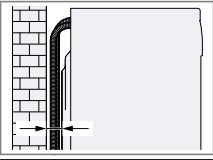
Installation location	Requirements
<p>Kitchen unit</p> 	<p>Only install the appliance underneath a continuous worktop that is securely connected to adjacent cabinets. Required niche width: 60 cm.</p>
<p>Against a wall</p> 	<p>Do not trap the hoses between the wall and the appliance.</p>

ATTENTION!

Residual water may freeze. Freezing residual water may damage the appliance and frozen hoses may burst.

- ▶ Do not install the appliance outdoors or in areas where there is a risk of frost.

4.4 Removing the transit bolts

The appliance is secured for transportation using transit bolts on the rear of the appliance.

Note: Keep the transit bolt screws and the sleeves in a safe place for future transport → *Page 56*.

en Installation and connection

1. Pull the hoses out of the holders.

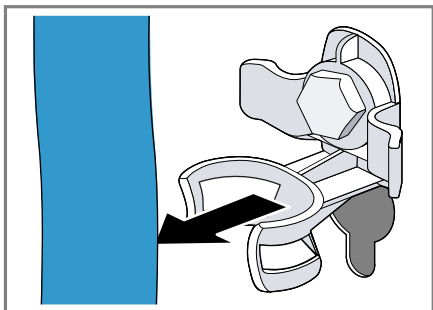

4. Remove the 4 sleeves.

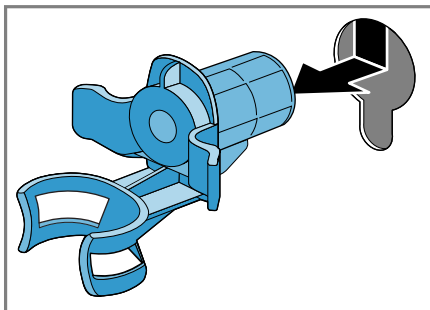

2. Unscrew ① and remove ② all 4 screws for the transit bolts with a WAF 13 wrench.

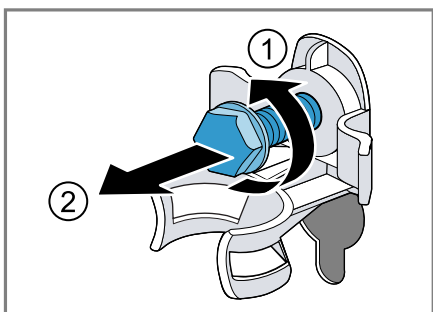

5. Put on the 4 cover caps.

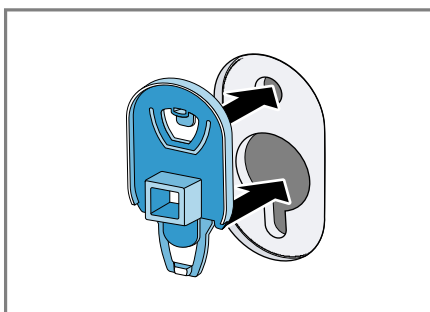

3. Pull the power cable out of the holder.

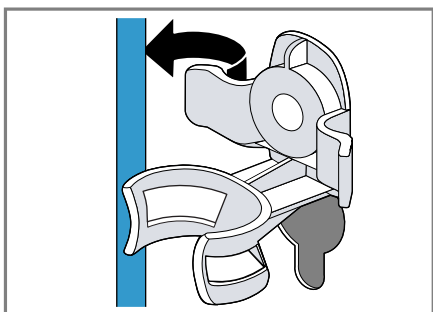

6. Press down on the 4 cover caps.

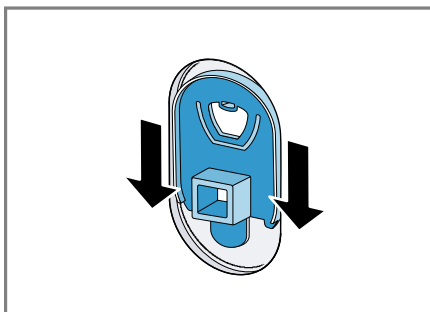

4.5 Removing the transport struts

1. Unscrew and remove the screws in the vertical transport struts using a T20 screwdriver.

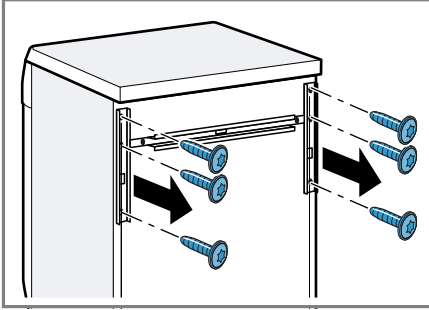

2. Remove the transport struts.

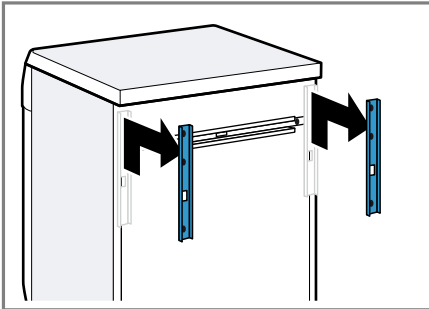

3. Undo and remove the screws in the horizontal transport strut using a T20 screwdriver.

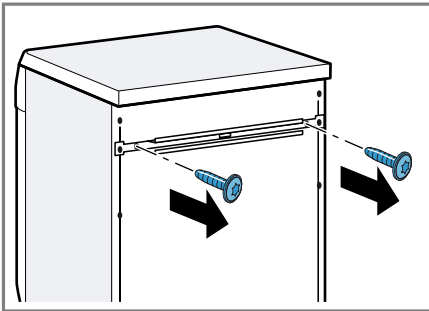

4. Remove the transport strut.

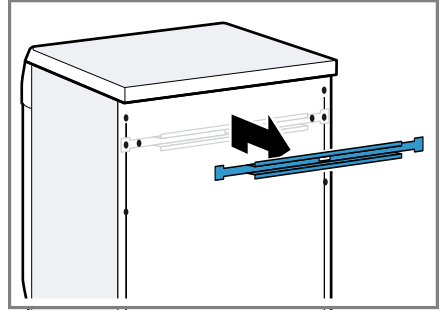

4.6 Connecting the appliance

Connecting the water inlet hose

⚠ WARNING **Risk of electric shock!**

The appliance contains live parts. Touching live parts is dangerous.

- ▶ Do not immerse the electrical AquaStop valve in water.
1. Connect the water inlet hose to a tap (26.4 mm = 3/4").

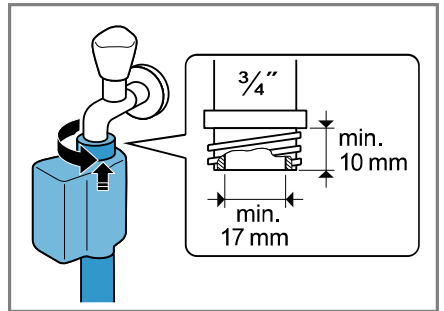

en Installation and connection

- When connecting to a 21 mm = 1/2" tap, first fit the adapter with a sealing washer.

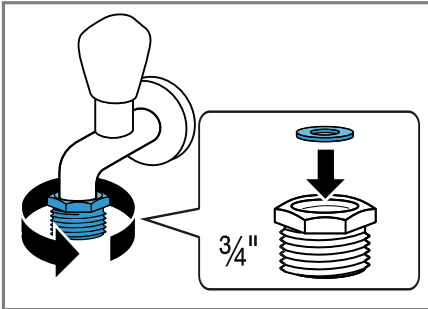

- Open the water tap carefully and check that the connection points are tight.

Water outlet connection types

This information is intended to help you to connect this appliance to the water outlet.

ATTENTION!

When draining, the water outlet hose is subject to water pressure and may come loose from the installed connection point.

- Secure the water outlet hose against unintentional loosening.

Note: Observe the draining heights. The maximum draining height is 100 cm.

Siphon

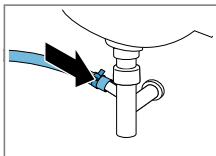

Secure the connection point with a (24–40 mm) hose clamp.

Sink

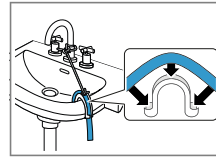

Fix and secure the water outlet hose with an elbow.

Plastic pipe with rubber sleeve or gully

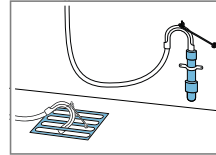

Fix and secure the water outlet hose with an elbow.

4.7 Aligning the appliance

In order to reduce noise and vibration and to prevent the appliance from moving, align the appliance correctly.

- Loosen the lock nuts using a WAF 17 wrench by turning it in a clockwise direction.

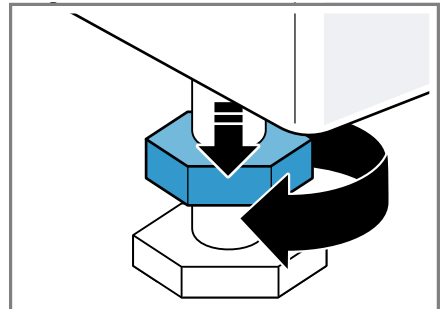

2. To align the appliance, turn the appliance feet. Check that the appliance is level using a spirit level.

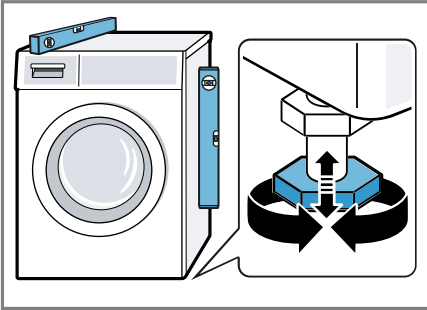

All appliance feet must stand firmly on the ground.

3. Screw the lock nuts tightly against the housing using a WAF 17 wrench.

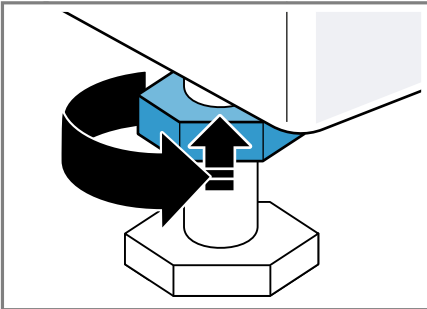

In doing so, hold the foot tight and do not adjust its height.

4.8 Connecting the appliance to the electricity supply

1. Insert the mains plug of the appliance's power cable in a socket nearby.

The connection details of the appliance can be found under Technical data → *Page 60*.

2. Check the mains plug is inserted properly.

5 Familiarising yourself with your appliance

5.1 Appliance

You can find an overview of the parts of your appliance here.

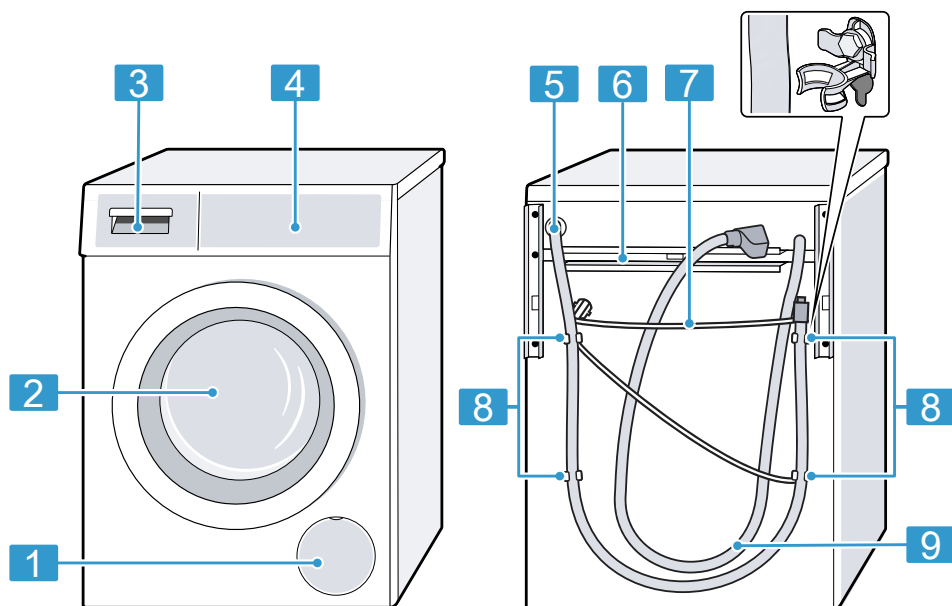

On certain models, specific details such as the colour and shape may differ from those pictured.

- | | |
|---|--|
| 1 | Maintenance flap for the drain pump → <i>Page 41</i> |
| 2 | Door |
| 3 | Detergent drawer → <i>Page 19</i> |
| 4 | Control panel → <i>Page 19</i> |
| 5 | Water outlet hose → <i>Page 16</i> |
| 6 | Transport struts → <i>Page 15</i> |
| 7 | Power cord → <i>Page 17</i> |

- | | |
|---|-----------------------------------|
| 8 | Transit bolts → <i>Page 13</i> |
| 9 | Water inlet hose → <i>Page 15</i> |

5.2 Detergent drawer

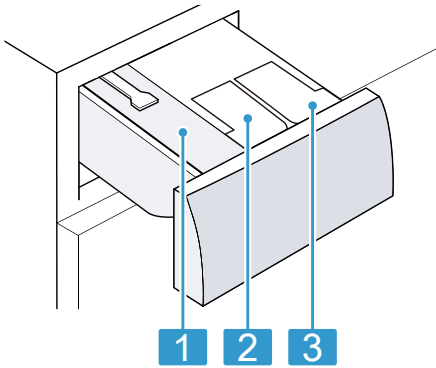

- | | |
|---|---|
| 1 | Manual dosing compartment |
| 2 | ☼/☼: Dispenser for fabric softener or detergent |
| 3 | ☼: Dispenser for detergent |

5.3 Control panel

You can use the control panel to configure all functions of your appliance and to obtain information about the operating status.

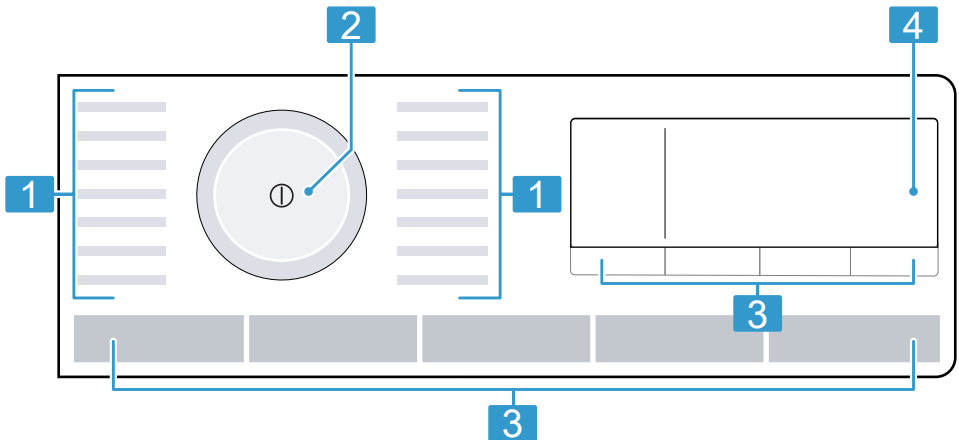

- | | |
|---|---------------------------------|
| 1 | Programmes |
| 2 | Programme selector
→ Page 31 |
| 3 | Buttons → Page 24 |
| 4 | Display → Page 21 |

6 Before using for the first time

Prepare the appliance for use.

6.1 Starting an empty washing cycle

Your appliance was inspected thoroughly before leaving the factory. To remove any residual water, run the first wash cycle without any laundry.

1. Press ①.

The switch-on process takes a few seconds.

2. Set the **Drum Clean** programme.
3. Close the door.
4. Pull out the detergent drawer.
5. Add washing powder to the manual dosing compartment.

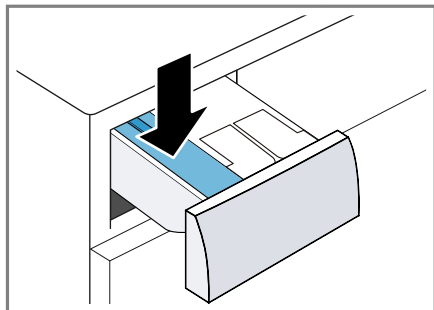

To prevent foaming, use only half of the amount of detergent recommended by the detergent manufacturer for light soiling. Do not use detergent suitable for woollens or delicates.

6. Push in the detergent drawer.
 7. Press ▷||| (Start/Reload/Pause) to start the programme.
- ✓ The display shows the remaining programme duration.
 - ✓ After the programme has ended, the display shows: **-0-**.

8. Start the first wash cycle or press ① to switch off the appliance.
→ "Basic operation", Page 31





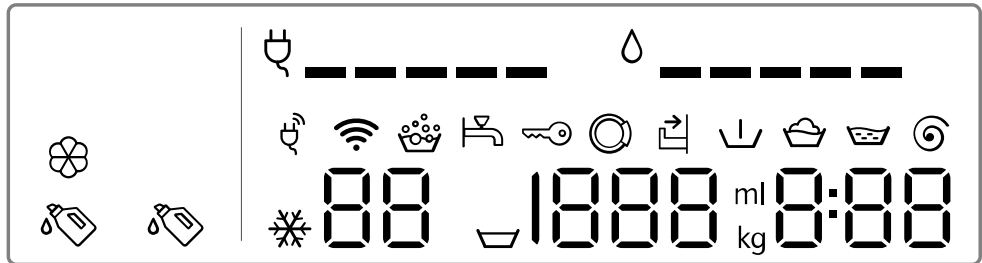





7 Display

The display shows the current settings, options or relevant information.







Display	Designation	More information
0:40 ¹	Programme duration/programme time remaining	Approximate expected programme duration or programme time remaining.
10h ¹	"Ready in" time	→ "Buttons", Page 24
10,0 kg ¹	Recommended load	The maximum load capacity for the selected programme in kg.
☒ - 1600	Spin speed	Set spin speed in rpm. → "Buttons", Page 24 0= No final spin, only draining ☒: Rinse Hold, no draining
❄ - 90	Temperature	Set temperature in °C. → "Buttons", Page 24 ❄ (cold)
↓	Prewash	Programme status
🧺	Wash	Programme status
🧺	Rinse	Programme status
🌀	Spin	Programme status
-P-	Pause	Programme status
-0-	End of programme	Programme status

¹ Example













Display	Designation	More information
	Childproof lock	<ul style="list-style-type: none"> ■ lights up: The childproof lock is activated. ■ flashes: The childproof lock is activated and the appliance has been operated. → <i>"Deactivating the childproof lock", Page 33</i>
	Energy consumption	<p>Energy consumption for the selected programme.</p> <ul style="list-style-type: none"> ■ — : Low energy consumption ■ ———— : High energy consumption
	Water consumption	<p>Water consumption for the selected programme.</p> <ul style="list-style-type: none"> ■ — : Low water consumption ■ ———— : High water consumption
	Wi-Fi	<ul style="list-style-type: none"> ■ Lights up: The appliance is connected to your home network. ■ Flashes: The appliance is trying to connect to your home network. → <i>"Home Connect ", Page 36</i>
	Energy manager	The appliance is connected to the smart energy system (energy manager). Connecting the appliance to the energy manager
	Dispenser for liquid detergent	<ul style="list-style-type: none"> ■ Lights up: The intelligent dosing system for liquid detergent is activated. ■ Flashes: The fill level of the dispenser is below the minimum level. → <i>"Intelligent dosing system", Page 34</i> <p> (liquid detergent)</p>
	Dispenser for liquid detergent or fabric softener.	<ul style="list-style-type: none"> ■ Lights up: The intelligent dosing system for liquid detergent or fabric softener is activated. ■ Flashes: The fill level of the dispenser is below the minimum level. → <i>"Intelligent dosing system", Page 34</i> <p> (liquid detergent)  (fabric softener)</p>
50 ml ¹	Basic dosage	<p>Basic dosage for detergent or fabric softener. → <i>"Basic dosage", Page 35</i></p>







¹ Example

Display	Designation	More information
	Foam detection system	The appliance has detected too much foam.
	Door	The door is unlocked and can be opened.
	Tap	<ul style="list-style-type: none"> ■ No water pressure. ■ The water pressure is too low.
	Detergent drawer	The detergent drawer has not been pushed in fully.
E:35 / -10 ¹	Error	Error code, error display, signal.
¹ Example		

8 Buttons



The selection of programme settings depends on the programme that is set. You can see the selection options for each programme in the overview for .

Button	Selection	More information
 (Start/Reload/ Pause)	<ul style="list-style-type: none"> ■ Start ■ Cancel ■ Pause 	Start, cancel or pause the programme.
varioSpeed 	<ul style="list-style-type: none"> ■ Activate ■ Deactivate 	Activate or deactivate a shorter programme duration. Note: Energy consumption increases. The washing result is not affected by this.
i-Dos 	<ul style="list-style-type: none"> ■ Activate ■ Deactivate ■ Basic dosage 	Briefly press the button to activate or deactivate the intelligent dosing system for liquid detergent  . Press the button for approx. 3 seconds to set the basic dosage. → "Intelligent dosing system", Page 34
i-Dos 	<ul style="list-style-type: none"> ■ Activate ■ Deactivate ■ Dispenser contents ■ Basic dosage 	Briefly press the button to activate or deactivate the intelligent dosing system for fabric softener  or liquid detergent  . Press the button for approx. 3 seconds to specify the contents of the dispenser or set the basic dosage. → "Intelligent dosing system", Page 34
-  + (- Ready in +)	Up to 24 hours	Set the programme end. The programme duration is already included in the set number of hours. Once the programme has started, the programme duration is displayed.
°C (Temperature Selection)	 - 90 °C	Adjust the temperature in °C.
 (Spin Speed Re- duction)	 - 1600	Adjust the spin speed or activate  (Rinse Hold). If  is selected, the water is not drained at the end of the washing cycle and the spin cycle is deactivated. The laundry remains in the rinsing water.

Button	Selection	More information
 (mains switch)	<ul style="list-style-type: none"> ■ Switch on ■ Switch off 	Switch the appliance on or off.
 (Remote Start)	<ul style="list-style-type: none"> ■ Activate ■ Deactivate ■ Open the Home Connect menu 	→ <i>"Remote start", Page 38</i>
 3 sek. (Child Lock 3 sec.)	<ul style="list-style-type: none"> ■ Activate ■ Deactivate 	→ <i>"Childproof lock", Page 33</i>
 (Spin Speed Reduction)	Multiple selection	Basic settings
 (Prewash)	<ul style="list-style-type: none"> ■ Activate ■ Deactivate 	<p>Activate or deactivate prewash, e.g. for washing heavily soiled laundry.</p> <p>Note: If the intelligent dosing system is activated, the detergent will be dispensed automatically for the prewash and the main wash. If the intelligent dosing system is deactivated, place the detergent for the prewash directly in the drum.</p>
 (Power Rinse x3)	<ul style="list-style-type: none"> ■ Activate ■ Deactivate 	<p>Activate or deactivate three additional rinse cycles. Recommended for particularly sensitive skin or in regions with very soft water.</p>
 (Easy Iron)	<ul style="list-style-type: none"> ■ Activate ■ Deactivate 	<p>Activate or deactivate the reduced creasing programme. In order to reduce creasing in the laundry, the spin cycle and the spin speed are adapted. The laundry is damp enough after washing that it needs to be hung out on a washing line.</p>

9 Programmes

Note: The laundry's care labels provide you with additional information about programme selection. Care symbols on the care labels

Programme	Description	Max. load (kg)
Cotton	<p>Wash hard-wearing items made from cotton, linen or blended fabrics.</p> <p>Also suitable as a short programme for normally soiled laundry when you activate varioSpeed .</p> <p>Programme setting:</p> <ul style="list-style-type: none"> ■ Max. 90 °C ■ Max. 1600 rpm 	10,0 5,0 ¹
Eco 40-60	<p>Wash items made from cotton, linen or blended fabrics.</p> <p>Note: Fabrics which can be washed from 40 °C  up to 60 °C  as per the care symbol can be washed together.</p> <p>The washing performance corresponds to the best possible washing performance class according to the legal requirements.</p> <p>For this programme, the washing temperature is automatically adjusted depending on the load size, in order to achieve the best possible energy efficiency with the best possible washing result. You cannot change the washing temperature.</p> <p>Programme setting:</p> <p>Note: The temperature cannot be adjusted in this programme and is set automatically.</p> <ul style="list-style-type: none"> ■ Max. - °C ■ Max. 1600 rpm 	10,0
Easy Care	<p>Wash items made from synthetic or blended fabrics.</p> <p>Programme setting:</p> <ul style="list-style-type: none"> ■ Max. 60 °C ■ Max. 1200 rpm 	4,0
Mix	<p>Wash items made from cotton, linen, or synthetic or blended fabrics.</p> <p>Suitable for lightly soiled laundry.</p> <p>Programme setting:</p> <ul style="list-style-type: none"> ■ Max. 60 °C 	4,0



¹ **varioSpeed**  activated

Programme	Description	Max. load (kg)
	<ul style="list-style-type: none"> ■ Max. 1600 rpm 	
Delicate/Silk	<p>Wash delicate, washable items made from silk, viscose and synthetic fabrics. Use a detergent that is suitable for delicates or silk.</p> <p>Note: Wash especially delicate items or items with hooks, eyelets or clips in a mesh laundry bag.</p> <p>Programme setting:</p> <ul style="list-style-type: none"> ■ Max. 40 °C ■ Max. 800 rpm 	2,0
 Wool	<p>Hand- or machine-washable items that are made from wool or contain wool. To prevent the laundry from shrinking, the drum moves the items very gently with long pauses. Use a detergent that is suitable for wool.</p> <p>Programme setting:</p> <ul style="list-style-type: none"> ■ Max. 40 °C ■ Max. 800 rpm 	2,0
powerSpeed 59 ¹	<p>Wash items made from cotton, linen, or synthetic or blended fabrics. Suitable for lightly and normally soiled laundry. Optimum washing results in under an hour.</p> <p>Programme setting:</p> <ul style="list-style-type: none"> ■ Max. 40 °C ■ Max. 1400 rpm 	5,0
Rinse	<p>Rinse and then spin the laundry, and drain the water.</p> <p>Programme setting: Max. 1600 rpm</p>	–
Spin/Drain	<p>Spin and drain the water. If you only want to drain the water, activate 0. The laundry is not spun.</p> <p>Programme setting: Max. 1600 rpm</p>	–
Hygiene	<p>Wash hard-wearing items made from cotton, linen or blended fabrics. Suitable for allergy sufferers and for strict hygiene requirements.</p> <p>Note: Once the set temperature has been reached, it remains constant throughout the entire washing process.</p> <p>Programme setting:</p> <ul style="list-style-type: none"> ■ Max. 60 °C 	6,5

¹ varioSpeed  activated

Programme	Description	Max. load (kg)
	<ul style="list-style-type: none"> ■ Max. 1600 rpm 	
Outdoor/Waterproofing	<p>Wash all-weather and outdoor clothing with membrane technology and water-resistant equipment. Suitable for washing and then waterproofing. Use a detergent for outdoor fabrics. Use a waterproofing agent that is suitable for machine-washing. Do not use fabric softener. Place the detergent for outdoor fabrics in the manual dosing compartment. If the programme stops before the last rinse cycle, add the waterproofing agent to the manual dosing compartment. Press  to resume the programme. → "Detergent drawer", Page 19</p> <p>After-treat the laundry in accordance with the manufacturer's instructions.</p> <p>Programme setting:</p> <ul style="list-style-type: none"> ■ Max. 40 °C ■ Max. 800 rpm 	1,0
Automatic 30°C	<p>Wash delicate items made from cotton, or synthetic or blended fabrics. Gentle laundry care. The degree of soiling and the type of fabric are automatically detected. The washing process is adapted.</p> <p>Note: The temperature and spin speed cannot be adjusted in this programme and are set automatically. The maximum temperature is 30 °C. The maximum spin speed is 1000 rpm.</p>	3,5
Drum Clean	<p>Cleaning and caring for the drum. Use this programme in the following cases:</p> <ul style="list-style-type: none"> ■ Before using the appliance for the first time ■ If you regularly wash at temperatures of 40 °C or lower ■ After a prolonged period of non-use <p>Use washing powder or a detergent that contains bleach. Halve the amount of detergent to avoid foaming. Do not use fabric softener. Do not use liquid detergent or detergent that is intended for woollens or delicates.</p>	–

¹ varioSpeed  activated

Programme	Description	Max. load (kg)
Super 15'/30'	<p>Note: The drum cleaning indicator will flash to remind you if you have not used a programme at 60 °C or higher for a long time.</p> <p>Wash items made from cotton, or synthetic or blended fabrics. Short programme for small items of lightly soiled laundry. The programme duration is approx. 30 minutes. If you wish to reduce the programme duration to 15 minutes, activate varioSpeed . The maximum load is reduced to 2,0 kg. Programme setting:</p> <ul style="list-style-type: none"> ■ Max. 40 °C ■ Max. 1200 rpm 	4,0
¹ varioSpeed  activated		

10 Accessories

Use original accessories. These have been made especially for your appliance.

	Use	Order number
Water inlet hose extension	Extend the water inlet hose for cold water or AquaStop (approx. 2.50 m).	WZ10131
Fixing brackets	Improves the stability of the appliance.	WX975600
Platform	Install the appliance at a raised height so that it can be easily loaded and unloaded.	WZWP20W

11 Laundry

Note: More detailed instructions for use can be found on www.siemens-home.bsh-group.com or by scanning the QR code on the title page of this user manual.

11.1 Preparing the laundry

ATTENTION!

Objects remaining in the laundry may damage the laundry and the drum.

- ▶ Remove all items from any pockets in your laundry before using the appliance.
- ▶ To protect your appliance and the laundry, prepare the laundry beforehand.
 - Empty any pockets
 - Brush sand out of all collars and pockets
 - Close bed covers and cushion covers
 - Close all zips, Velcro fasteners, hooks and eyes

- Tie cloth belts, apron strings, etc. together or use a laundry bag.
- Tie together longer drawstrings, and tie cords with solid end-pieces in hoods or trousers
- Remove curtain hooks and lead strips or use a mesh laundry bag
- Use a mesh laundry bag for small items of laundry, such as children's socks
- Some stubborn or dried-in stains can be removed by washing several times
- Wash large and small items of laundry together
- Do not rub fresh stains but dab them with soapy water
- Separate items of laundry and shake them out, or observe the programme description

12 Detergents and care products

Notes

- More detailed instructions for use can be found on www.siemens-home.bsh-group.com or by scanning the QR code on the title page of this user manual.
- Observe the information on safety → *Page 4* and preventing material damage → *Page 10*.

The manufacturer's instructions for use and dosage can be found on the packaging.

Notes

- Only use liquid detergents that are self-flowing
- Do not mix different liquid detergents
- Do not mix detergent and fabric softener
- Do not use products that have expired or are highly congealed
- Do not use products containing solvents, caustic agents or volatile substances (e.g. bleach)
- Use dyes sparingly as salt may damage stainless steel
- Do not use bleaching agents in the appliance
- Do not pour vinegar into the dispensers → *Page 34* of the intelligent dosing system

13 Basic operation

Note: You can find further information in the digital instruction manual by scanning the QR code in the table of contents or on www.siemens-home.bsh-group.com.

13.1 Switching on the appliance

Requirement: The appliance has been correctly installed and connected.

→ *"Installation and connection", Page 12*

- ▶ Press ①.

The switch-on process takes a few seconds.

- ✓ An audible function test is carried out.

Note: The lighting for the drum goes out automatically.

13.2 Setting a programme

1. Turn the programme selector and set the required programme.
→ *"Programmes", Page 26*
2. If necessary, adjust the programme settings → *Page 31*.

13.3 Adjusting the programme settings

Requirement: A programme has been set.

→ *"Setting a programme", Page 31*

- ▶ Adjust the programme settings.
→ *"Buttons", Page 24*

Notes

- The programme settings are not saved permanently for the programme.
- The setting is saved if you activate or deactivate the intelligent dosing system.

13.4 Loading laundry

Note: To prevent creasing, take note of the maximum load for the
→ *"Programmes", Page 26*.

Requirement: The laundry is prepared.

→ "Laundry", Page 30

1. Open the door.
Make sure that the drum is empty.
2. Place the laundry in the drum.
3. Close the door.
Ensure that there is no laundry trapped in the door.

13.5 Adding detergent and care product

For programmes in which intelligent dosing is not possible or desirable, you can add detergent manually.

Tip: In addition to intelligent dosing, you can also add additional care product for laundry, e.g. stain remover, starch or bleach, to the manual dosing compartment. Do not add any additional detergent to the manual dosing compartment to avoid overdosage and/or foaming.

Note: Observe the information about detergents and care products
→ Page 31.

1. Pull out the detergent drawer.
2. Pour in detergent.
→ "Detergent drawer", Page 19
3. If required, add the care product.
4. Push in the detergent drawer.

13.6 Starting the programme

Note: If you want to change the time until the programme ends, set the "Ready in" time first.

- ▶ Press ▷00.
- ✓ The drum rotates and load detection takes place. This can take up to 2 minutes, after which water enters the drum.



- ✓ The display shows either the programme duration or the "Ready in" time.
- ✓ After the programme has ended, the display shows: **-0-**.

13.7 Soaking laundry

Note: No additional detergent is required. The washing solution is then used for washing.

1. Start the programme.
2. To pause the programme, after approx. 10 minutes, press ▷00.
3. To resume the programme, after the desired soaking time, press ▷00.

13.8 Adding laundry

1. Press ▷00.
The appliance pauses.
Note: If  appears, it is not possible to add laundry.
When  goes out, it is possible to add laundry.
2. Open the appliance door.
3. Add or remove laundry.
4. Close the appliance door.
5. Press ▷00.

13.9 Cancelling the programme

1. Press ▷00.
2. Open the appliance door.
The appliance door remains locked for safety reasons if the temperature and water levels are high.
 - If the temperature is high, start the **Rinse** programme.
 - If the water level is high, start the **Spin** programme or select a suitable programme for draining.
→ "Programmes", Page 26

3. Remove the laundry → Page 33.

13.10 Resuming the programme when the programme status is Rinse Hold

1. Start the **Spin** programme or select a suitable programme for draining.
→ "Programmes", Page 26
2. Press ▷□□.

13.11 Unloading the laundry

1. Open the appliance door.
2. Remove the laundry.

13.12 Switching off the appliance

1. Press ①.
2. Wipe the rubber gasket dry and remove any foreign objects.

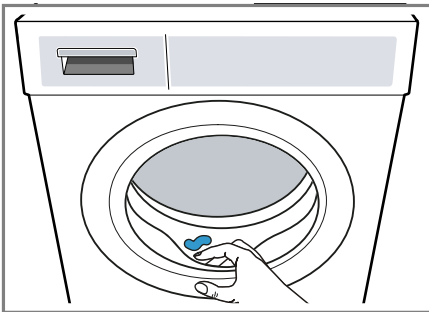

3. Leave the appliance door and detergent drawer open so that residual water can evaporate.

14 Childproof lock

Secure your appliance against being operated unintentionally using the controls.

14.1 Activating the childproof lock

- ▶ Press and hold the two ☞ 3 sek. buttons for approx. 3 seconds.
- ✓ The display shows ☞.
- ✓ The controls are locked.
- ✓ The childproof lock remains active even after the appliance has been switched off.

14.2 Deactivating the childproof lock

Requirement: To deactivate the childproof lock, the appliance must be switched on.

- ▶ Press and hold the two ☞ 3 sek. buttons for approx. 3 seconds.
So that the programme currently running is not cancelled, the programme selector must be set to the initial programme.
- ✓ ☞ goes out in the display.

15 Intelligent dosing system

The optimum quantities of liquid detergent and fabric softener are dispensed automatically depending on the programme and settings.

15.1 Starting the programme with intelligent dosing system

If you do not want to dose liquid detergent and fabric softener manually, use the intelligent dosing system. This function is available depending on the selected programme and is activated automatically.

Note

If you are using the intelligent dosing system, do not add additional detergent or fabric softener into the compartment for manual dosing.

→ *"Adding detergent and care product"*, Page 32

If you want to dose manually for a set programme, observe the following information:

- Deactivate the intelligent dosing system before starting the programme. The selected settings are retained even after the appliance has been switched off.
 - *"Buttons"*, Page 24
 - *"Buttons"*, Page 24
- Pour detergent or fabric softener into the compartment for manual dosing.
 - *"Adding detergent and care product"*, Page 32
- Activate the intelligent dosing system once the programme has ended.
 - *"Buttons"*, Page 24
 - *"Buttons"*, Page 24

Requirements

- The laundry is prepared.
 - *"Preparing the laundry"*, Page 30
- The laundry is sorted. Sorting laundry
- The laundry is placed in the appliance.
 - *"Loading laundry"*, Page 31
- The programme is set.
 - *"Setting a programme"*, Page 31
- The intelligent dosing system is activated.
 - *"Buttons"*, Page 24
 - *"Display"*, Page 22
 - *"Display"*, Page 22

1. Fill the dispensers → Page 34.

To replace the contents of the dispenser with another product, clean the detergent drawer → Page 40.

2. If required, adjust the contents of the dispenser → Page 35.
3. If required, adjust the basic dosage → Page 35.
4. If required, adjust the programme settings → Page 31.
5. Start the programme → Page 32.
- ✓ After the programme has ended, the display shows: **-0-**.
6. The
 - *"Unloading the laundry"*, Page 33.

15.2 Filling the dispensers

If you want to use the intelligent dosing system or if the appliance displays an indication during operation of the appliance, fill the dispensers.

Note: Fill the dispensers only with suitable detergent and care products → Page 31.

If you want to add more liquid detergent or fabric softener in the dispenser, use the same product.



If you want to replace the liquid detergent or fabric softener in the dispenser with another product, clean the detergent drawer beforehand.

→ "Cleaning the detergent drawer", Page 40

If you want to use both dispensers for liquid detergent, adjust the contents of the dispensers → Page 35.

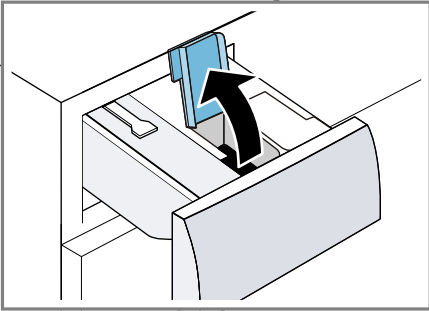
1. Pull out the detergent drawer.
2. Open the dispenser cover.



3. Pour liquid detergent  and fabric softener  into the relevant dispensers.
→ "Detergent drawer", Page 19

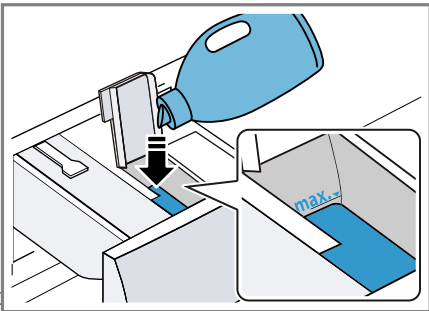

Do not exceed the marking for the maximum filling level when filling.

4. Close the dispenser cover.

Note: To prevent the liquid detergent or fabric softener from drying out, close the dispenser cover immediately after filling.

5. If required, add cleaning aids such as stain remover, water softener or bleach into the compartment for manual dosing.

→ "Adding detergent and care product", Page 32







6. Push in the detergent drawer.
7. Adjust the basic dosage
→ Page 35.

15.3 Dispenser contents

Notes

- If you change the contents of the dispenser, the basic dosage for this dispenser is reset.
- If you use both dispensers for liquid detergent, you must select a dispenser which is to be used during washing.



Adjusting the dispenser contents

1. Press and hold **i-Dos**  for approx. 3 seconds.
2. To set , press **i-Dos** .
- ✓ The display shows .
3. To set , press **i-Dos**  again.
4. To end the setting process, wait briefly.

15.4 Basic dosage

The basic dosage depends on the manufacturer's instructions for the detergent, the water hardness and the degree of soiling of the laundry. Always set a basic dosage that corresponds to the dosage for a standard load of 4.5 kg. Detergent dosage

Adjusting the basic dosage

1. Press and hold **i-Dos**  for approx. 3 seconds.
- ✓ The display shows the basic dosage set for .
2. To adjust the setting, press .

3. To end the setting process, wait briefly.

Note: To adjust the basic dosage for ☼, repeat the steps with **i-Dos** ☺.

16 Home Connect

This appliance is network-capable. Connecting your appliance to a mobile device lets you control its functions via the Home Connect app, adjust its basic settings and monitor its operating status.

Note: You can find further information in the digital instruction manual by scanning the QR code in the table of contents or on www.siemens-home.bsh-group.com.

The Home Connect services are not available in every country. The availability of the Home Connect function depends on the availability of Home Connect services in your country. You can find information about this at: www.home-connect.com.

- → "Connecting the appliance to a WLAN home network (Wi-Fi) with WPS function", Page 36
- → "Connecting the appliance to a WLAN home network (Wi-Fi) without WPS function", Page 37

The Home Connect app guides you through the entire login process. Follow the instructions in the Home Connect app to configure the settings.

Tips

- Please consult the documents supplied by Home Connect.
- Please also follow the instructions in the Home Connect app.

Notes

- Please note the safety precautions in this instruction manual and make sure that they are also ob-

served when operating the appliance via the Home Connect app.
→ "Safety", Page 4

- Operating the appliance on the appliance itself always takes priority. During this time it is not possible to operate the appliance using the Home Connect app.

16.1 Connecting the appliance to a WLAN home network (Wi-Fi) with WPS function

Requirements

- Your router has a WPS function.
- Wi-Fi is activated on the router.
- The Wi-Fi basic setting is activated on the appliance.
→ "Activating Wi-Fi on the appliance", Page 38
- The appliance receives signals from the WLAN home network (Wi-Fi) at its installation location.
- The Home Connect app is installed on your mobile device.

1. Press and hold  for at least 3 seconds.

✓ The display shows **Aut.**

2. Press  .

3. Press the WPS button on the router within the next 2 minutes.

Take note of the information in the documents for your router.

✓  flashes on the display.

✓ The device connects to the Wi-Fi home network.

✓ If the display shows and  lights up permanently, the appliance is connected to the Wi-Fi home network.

4. If the appliance is not connected to the Wi-Fi home network, the display shows **Err.**





- Check whether the appliance is within the range of the Wi-Fi home network.
 - Reconnect the appliance to the Wi-Fi home network with WPS function.
5. Connect the appliance to the Home Connect app. → *Page 37*

16.2 Connecting the appliance to a WLAN home network (Wi-Fi) without WPS function

If your router does not have a WPS function, you can connect the appliance to your WLAN home network (Wi-Fi) manually.

Requirements

- Wi-Fi is activated on the router.
- The Wi-Fi basic setting is activated on the appliance.
→ *"Activating Wi-Fi on the appliance", Page 38*
- The appliance receives signals from the WLAN home network (Wi-Fi) at its installation location.
- The Home Connect app is installed on your mobile device.

1. Press and hold  for at least 3 seconds.
 - ✓ The display shows **Aut.**
2. Set the programme to position 2.
 - ✓ The display shows **SAP.**
3. Press  .
 - ✓  flashes on the display.
 - ✓ The appliance now sets up its own Wi-Fi home network with the name (SSID) HomeConnect.
4. Call up the Wi-Fi settings on the mobile device.

Connect the mobile device to the HomeConnect Wi-Fi network and enter the Wi-Fi password (key) HomeConnect.

- ✓ Your mobile device connects to the appliance. The connection process may take up to 60 seconds.
5. Open the Home Connect app on your mobile device and carry out the steps in the app.
 6. In the Home Connect app, enter the network name (SSID) and password (key) for your home network.
 7. Carry out the steps in the Home Connect app to connect the appliance.
 - ✓ If the display shows and  lights up permanently, the appliance is connected to the Wi-Fi home network.
 8. If the appliance is not connected to the Wi-Fi home network, the display shows **Err.**
 - Check whether the appliance is within the range of the Wi-Fi home network.
 - Reconnect the appliance to the Wi-Fi home network with WPS function.
 9. Connect the appliance to the Home Connect app → *Page 37.*

16.3 Connecting the appliance to the Home Connect app

Requirements

- The appliance is connected to the WLAN home network (Wi-Fi).
 - The Home Connect app is open and you have logged on.
1. Set the programme to position 3.
 - ✓ The display shows **APP.**

2. Press **▷**.

- ✓ The appliance connects to the Home Connect app.
- 3. Once your appliance is displayed in the Home Connect app, carry out the last steps in the Home Connect app.
- ✓ If the display shows , the appliance is connected to the Home Connect app.

16.4 Activating Wi-Fi on the appliance

Note: When Wi-Fi is activated, the energy consumption increases in comparison to the values specified in the consumption value table.

1. Press and hold **□** for approx. 3 seconds.
2. Set the programme to position 4.
- ✓ The display shows **Con.**
3. Press **▷** repeatedly until the display shows **On.**
- ✓ Wi-Fi is activated.

Note: If Wi-Fi is activated, the appliance will not switch itself off automatically.

16.5 Deactivating Wi-Fi on the appliance

1. Press and hold **□** for at least three seconds.
2. Set the programme to position 4.
- ✓ The display shows **Con.**
3. Press **▷** repeatedly until the display shows **OFF.**
- ✓ Wi-Fi is deactivated.

Note: The connection is automatically re-established when the Wi-Fi is switched back on.

16.6 Resetting the appliance network settings

1. Press and hold **□** for at least 3 seconds.
2. Set the programme to position 5.
- ✓ The display shows **rES.**
3. Press **▷**.
- ✓ The display shows .
4. Press **▷**.
- ✓ The network settings are reset.
- ✓ If **End** is shown on the display, the network settings are reset.

16.7 Remote start

Enable the appliance for remote start via the Home Connect app.

Activating remote start

Notes

- Remote start is deactivated for safety reasons in the following circumstances:
 - Open the appliance door.
 - Press **▷**.
 - Press **□**.
 - Switch off the appliance.
 - Following a power cut.
- Remote start cannot be activated for safety reasons in the following circumstances:
 - The appliance door is open.
 - The detergent drawer has not been pushed in fully.

Requirements

- The appliance is connected to your Wi-Fi home network.
- The appliance is connected to the Home Connect app.
- A programme is selected.
- ▶ Press **□**.
If you press and hold the button for at least 3 seconds, the Home Connect menu opens.

If you briefly press the button, the appliance is enabled for remote start via the Home Connect app. If you open the appliance door, the function is automatically deactivated.

- ✓  lights up.

Note: To deactivate the function, press .

16.8 Remote diagnostics

Customer Service can use Remote Diagnostics to access your appliance if you contact them, have your appliance connected to the Home Connect server and if Remote Diagnostics is available in the country in which you are using the appliance.

Tip: For further information and details about the availability of Remote Diagnostics in your country, please visit the service/support section of your local website: www.home-connect.com

16.9 Data protection

Please see the information on data protection.

The first time your appliance is registered on a home network connected to the Internet, your appliance will transmit the following types of data to the Home Connect server (initial registration):

- Unique appliance identification (consisting of appliance codes as well as the MAC address of the Wi-Fi communication module installed).
- Security certificate of the Wi-Fi communication module (to ensure a secure data connection).
- The current software and hardware version of your appliance.
- Status of any previous reset to factory settings.

This initial registration prepares the Home Connect functions for use and is only required when you want to use the Home Connect functions for the first time.

Note: Please note that the Home Connect functions can only be utilised with the Home Connect app. Information on data protection can be retrieved in the Home Connect app.

17 Basic settings

You can configure the appliance to meet your needs.

Note: You can find further information in the digital instruction manual by scanning the QR code in the table of contents or on www.siemens-home.bsh-group.com .

18 Cleaning and servicing

To keep your appliance working efficiently for a long time, it is important to clean and maintain it carefully.

Note: You can find further information in the digital instruction manual by scanning the QR code in the table of contents or on www.siemens-home.bsh-group.com .

18.1 Cleaning the drum

CAUTION **Risk of injury!**

Permanently washing at low temperatures and a lack of ventilation for the appliance may damage the drum and cause injury.

- ▶ Regularly run a programme for cleaning the drum or wash at temperatures of at least 60 °C.

en Cleaning and servicing

- ▶ Leave the appliance to dry after every operation with the door open, and leave the detergent drawer to dry.
- ▶ Run the **Drum Clean** programme without laundry and using all-purpose washing powder.

18.2 Cleaning the detergent drawer

If you want to replace the liquid detergent or fabric softener in the dispenser with another product or if the detergent drawer is dirty, clean the detergent dispenser.

ATTENTION!

The pump unit contains electrical components. Electrical components may be damaged if they come into contact with liquids.

- ▶ Do not clean the pump unit in the dishwasher and do not immerse it in water.
- ▶ Protect the electrical connection on the rear against water, detergent and fabric softener residue.

1. Switch off the appliance.
→ "Switching off the appliance",
Page 33
2. Pull out the detergent drawer.
3. Press down on the insert and remove the detergent drawer.

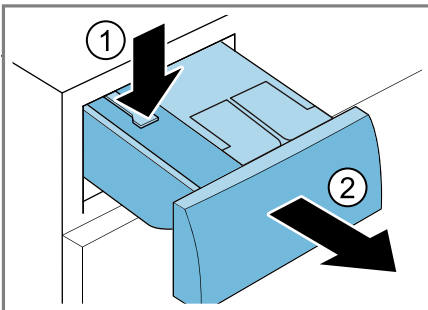

4. Remove the pump unit.

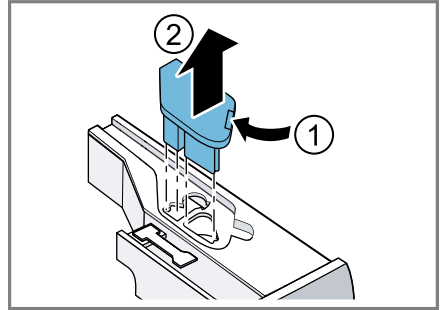

5. Unclip the detergent drawer cover and remove it.

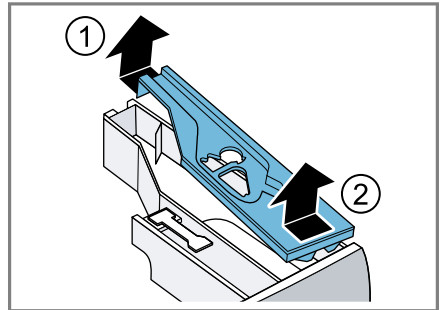

6. Empty the detergent drawer.

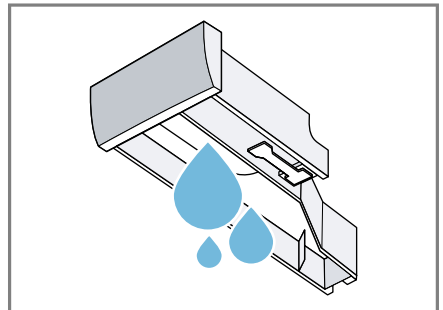

7. Clean the pump unit with a damp cloth.

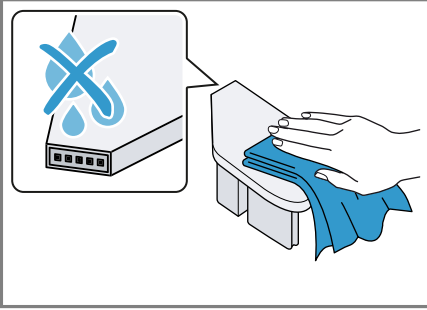

8. Clean the detergent drawer and the cover with a soft, damp cloth or hand shower.

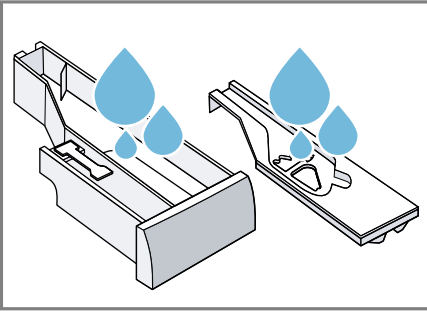

9. Dry the detergent drawer, cover and pump unit and reinsert them.

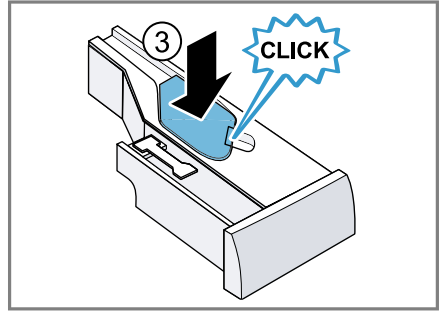
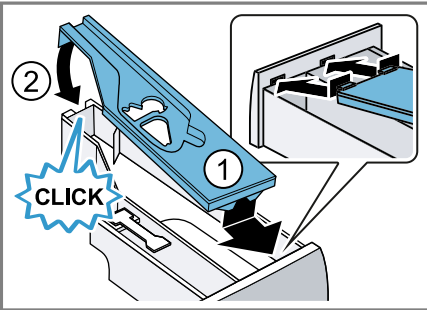

10. Clean the housing of the detergent drawer in the appliance.

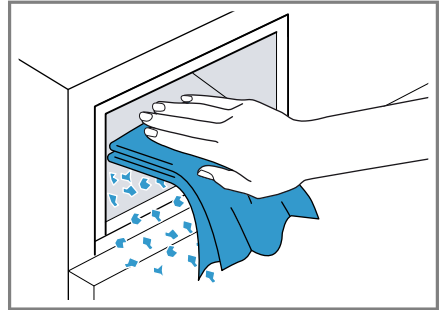

11. Push in the detergent drawer.

18.3 Cleaning the drain pump

Clean the drain pump in the event of faults, e.g. blockages or rattling noises.

Emptying the drain pump

1. Turn off the water tap.
2. Switch off the appliance.
3. Disconnect the appliance's mains plug from the power supply.

en Cleaning and servicing

4. Open and remove the service flap.

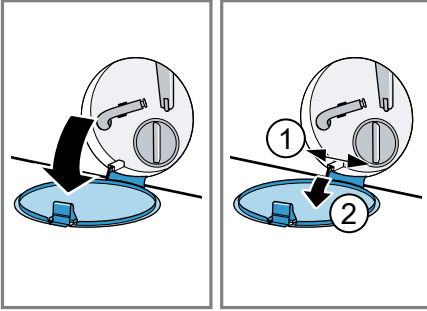

5. Slide a sufficiently large container under the opening.

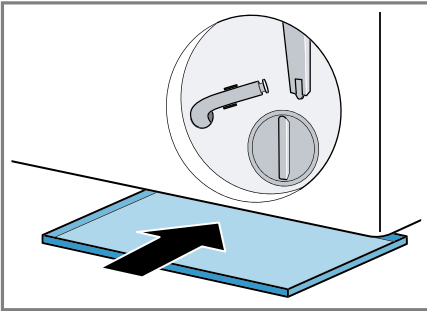

6. Take the drain hose out of the holder.

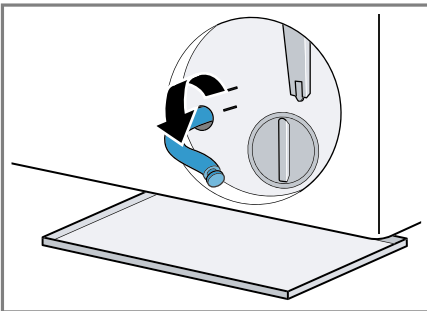

7. **⚠ CAUTION - Risk of scalding!**

When you wash at high temperatures, the detergent solution gets hot.

- Do not touch the hot detergent solution.

To allow the detergent solution to flow out into the container, remove the sealing cap.

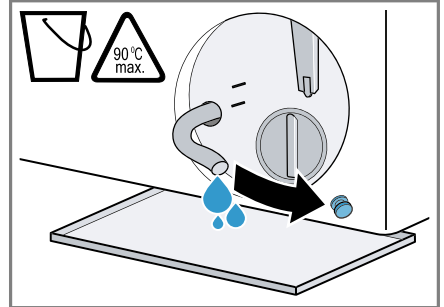

8. Firmly press on the sealing cap.

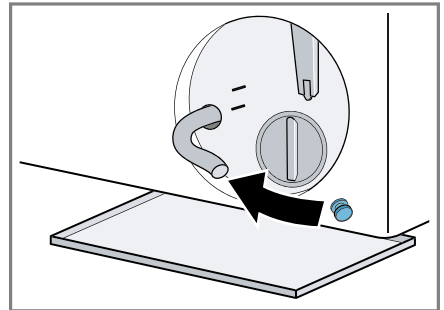

9. Insert the drain hose into the holder.

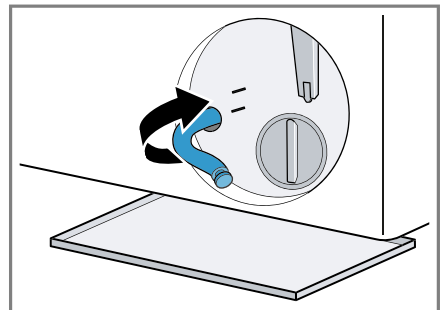

Cleaning the drain pump

Requirement: The drain pump is empty. → Page 41

1. Since water may remain in the drain pump, unscrew the pump cap carefully.
 - The filter insert in the pump housing may become stuck due to coarse particles of dirt. Loosen the dirt and remove the filter insert.

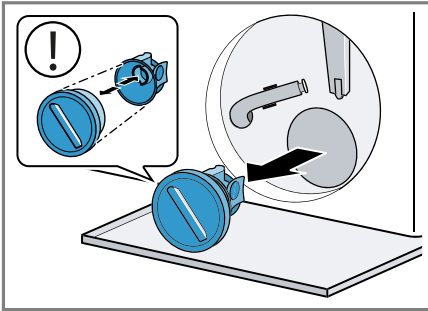

2. Clean the interior, the thread on the pump cap and the pump housing.

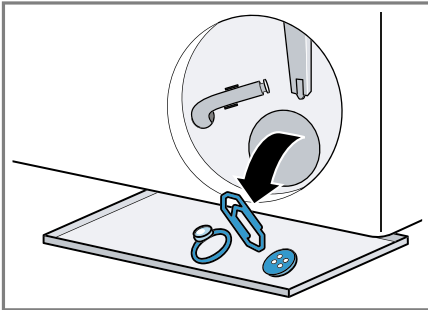

The pump cap is comprised of two parts which can be taken apart for cleaning.

3. Ensure that both impellers can turn.

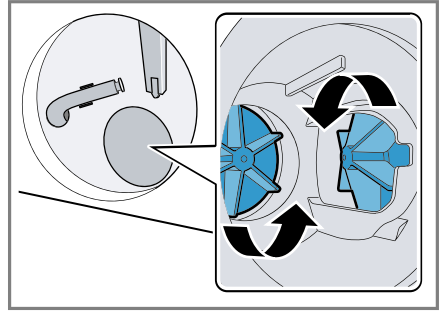

4. Insert the pump cap.
 - Ensure that the parts of the pump cap are correctly assembled.

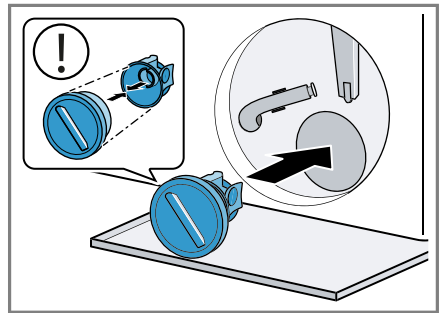

5. Screw the pump cap as far as it will go.

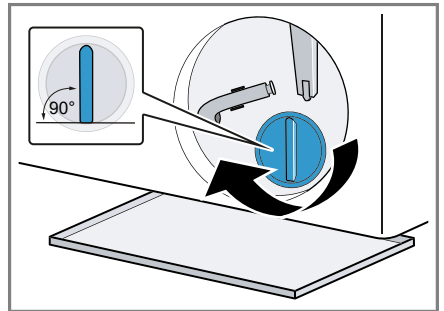

The handle on the pump cap must be in a vertical position.

6. Insert and close the service flap.

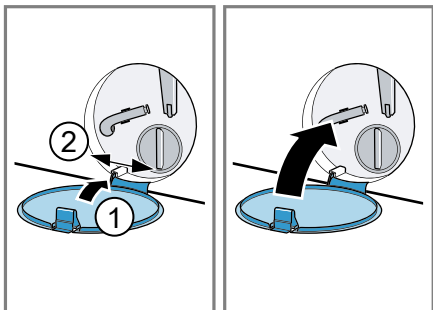

18.4 Cleaning the intake opening in the rubber gasket

Regularly check the intake opening in the rubber gasket for any blockages and clean the intake opening.

1. Open the appliance door.
2. Remove any blockages from the intake opening.

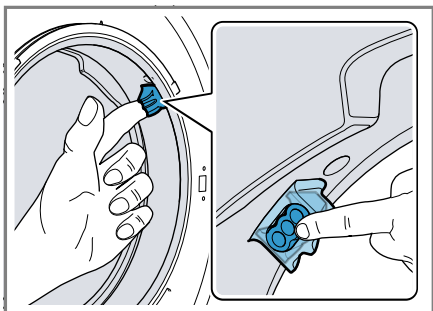

Note: Do not use any sharp or pointed objects.

19 Troubleshooting

You can rectify minor faults on your appliance yourself. Read the troubleshooting information before contacting after-sales service. This will avoid unnecessary costs.





WARNING







Risk of electric shock!

Incorrect repairs are dangerous.

- ▶ Repairs to the appliance should only be carried out by trained specialist staff.
- ▶ Only use genuine spare parts when repairing the appliance.
- ▶ If the power cord of this appliance is damaged, it must be replaced by the manufacturer, the manufacturer's Customer Service or a similarly qualified person in order to prevent any risk.

Fault	Cause and troubleshooting
The display goes out and  flashes.	Energy-saving mode is active <ul style="list-style-type: none"> ▶ Press any button. ✓ The symbol lights up again.
"E:30 / -80"	Drain pipe or water outlet hose is blocked. <ul style="list-style-type: none"> ▶ Clean the drain pipe and the water outlet hose. Drain pipe or water drain hose is caught or jammed. <ul style="list-style-type: none"> ▶ Ensure that the drain pipe and water drain hose are not kinked or trapped. Drain pump is blocked. <ul style="list-style-type: none"> ▶ → <i>"Cleaning the drain pump", Page 41</i> The water outlet hose is connected too high. <ul style="list-style-type: none"> ▶ Install the water outlet hose at a maximum height of 1 metre. Pump cover is not correctly assembled. <ul style="list-style-type: none"> ▶ Correctly assemble the pump cover. Detergent dosage is too high. <ul style="list-style-type: none"> ▶ Immediate measure: Mix one tablespoon of fabric softener with 0.5 litres of water and pour the mixture into the compartment for manual dosing (not for outdoor clothing, sportswear or items stuffed with down). ▶ If intelligent dosing is activated, reduce the basic dosage → <i>Page 35</i>. ▶ If you dose manually, reduce the amount of detergent for the next washing cycle with the same load.



Fault	Cause and troubleshooting
"E:30 / -80"	<p>Unapproved extension installed on the water drain hose.</p> <ul style="list-style-type: none"> ▶ Remove any unapproved extensions from the water hose. Connecting the appliance <hr/> <p>The pump cap is not fully screwed in.</p> <ul style="list-style-type: none"> ▶ Ensure that the pump cap is screwed in all the way into the appliance. The handle on the pump cap must be in a vertical position.
"E:36 / -25 / -26"	<p>Drain pump is blocked.</p> <ul style="list-style-type: none"> ▶ → <i>"Cleaning the drain pump"</i>, Page 41
"E:38 / -25 / -26"	<p>Drain pump is blocked.</p> <ul style="list-style-type: none"> ▶ → <i>"Cleaning the drum"</i>, Page 39 if the fault is displayed again, ▶ → <i>"Cleaning the drain pump"</i>, Page 41 <hr/> <p>Inlet opening of the rubber gasket is blocked.</p> <ul style="list-style-type: none"> ▶ → <i>"Cleaning the intake opening in the rubber gasket"</i>, Page 44
"E:10 / -00 / -10 / -20"	<p>The pump for the intelligent dosing system is blocked.</p> <ol style="list-style-type: none"> 1. Switch off the appliance. 2. Clean the pump unit. → <i>"Cleaning the detergent drawer"</i>, Page 40 3. If this indicator appears again, call our after-sales service. → <i>"Customer Service"</i>, Page 57 <p>Note: You can start the washing programme if you deactivate the intelligent dosing system and dose manually. → <i>"Buttons"</i>, Page 24</p>
	<p>The water pressure is low. No remedial action possible.</p> <hr/> <p>The filter in the water inflow is blocked.</p> <ul style="list-style-type: none"> ▶ Clean the water inflow filter. <hr/> <p>The tap is turned off.</p> <ul style="list-style-type: none"> ▶ Turn on the tap. <hr/> <p>The water inlet hose is kinked or jammed.</p> <ul style="list-style-type: none"> ▶ Ensure that the water inlet hose is not kinked or jammed.

Fault	Cause and troubleshooting
"E:35 / -10"	<p>There is water in the base trough.</p> <ul style="list-style-type: none"> ▶ Turn off the water tap. ▶ Call the after-sales service. → <i>"Customer Service", Page 57</i> <hr/> <p>The appliance is leaking.</p> <ul style="list-style-type: none"> ▶ Turn off the water tap. ▶ Call the after-sales service. → <i>"Customer Service", Page 57</i>
	<p>The detergent drawer has not been pushed in as far as it can go.</p> <ul style="list-style-type: none"> ▶ Push the detergent drawer in as far as it will go. <hr/> <p>The pump unit is not inserted.</p> <ol style="list-style-type: none"> 1. Insert the pump unit into the detergent drawer. → <i>"Cleaning the detergent drawer", Page 40</i> 2. Push the detergent drawer in as far as it will go.
	<p>Detergent dosage is too high.</p> <ul style="list-style-type: none"> ▶ Immediate measure: Mix one tablespoon of fabric softener with 0.5 litres of water and pour the mixture into the compartment for manual dosing (not for outdoor clothing, sportswear or items stuffed with down). ▶ If intelligent dosing is activated, reduce the basic dosage → <i>Page 35</i>. ▶ If you dose manually, reduce the amount of detergent for the next washing cycle with the same load.
 lights up.	<p>The temperature is too high.</p> <ul style="list-style-type: none"> ▶ Wait until the temperature has dropped. ▶ → <i>"Cancelling the programme", Page 32</i>
	<p>Water level is too high.</p> <ul style="list-style-type: none"> ▶ Start the Drain programme.
	<p>Laundry is caught in the door.</p> <ol style="list-style-type: none"> 1. Open the door again. 2. Remove any trapped laundry. 3. Close the door. 4. Press  to start the programme.
 flashes.	<p>Door is not closed.</p> <ol style="list-style-type: none"> 1. Close the door. 2. Press  to start the programme.

Fault	Cause and troubleshooting
All other error codes.	Malfunction ▶ Call the after-sales service. → "Customer Service", Page 57
"E:30/-20"	Solenoid valve defective. ▶ Call the after-sales service. → "Customer Service", Page 57
	Detergent dosage is too high. ▶ If you dose manually, reduce the amount of detergent for the next washing cycle with the same load.
	Additional water is added. ▶ Do not add any extra water to the appliance while it is operating.
The appliance is not working.	The mains plug of the power cord is not plugged in. ▶ Connect the appliance to the power supply.
	The circuit breaker is faulty. ▶ Check the circuit breaker in the fuse box.
	There has been a power cut. ▶ Check whether the lighting in your kitchen or other appliances are working.
The programme does not start.	You have not pressed ▷00. ▶ Press ▷00.
	Door is not closed. 1. Close the door. 2. Press ▷00 to start the programme.
	Childproof lock is activated. ▶ → "Deactivating the childproof lock", Page 33
	- Ⓞ + is activated. ▶ Check whether - Ⓞ + is activated. → "Buttons", Page 24
	Laundry is caught in the door. 1. Open the door again. 2. Remove any trapped laundry. 3. Close the door. 4. Press ▷00 to start the programme.
	The detergent drawer has not been pushed in as far as it can go. ▶ Push the detergent drawer in as far as it will go.
The pump for the intelligent dosing system is blocked. 1. Switch off the appliance.	

Fault	Cause and troubleshooting
The programme does not start.	<p>2. Clean the pump unit. → <i>"Cleaning the detergent drawer", Page 40</i></p> <p>3. If this indicator appears again, call our after-sales service. → <i>"Customer Service", Page 57</i></p> <p>Note: You can start the washing programme if you deactivate the intelligent dosing system and dose manually. → <i>"Buttons", Page 24</i></p>
The door cannot be opened.	<p>☒ is activated.</p> <ul style="list-style-type: none"> ▶ Continue the programme by selecting Spin or Drain and pressing ▷☐☐. → <i>"Resuming the programme when the programme status is Rinse Hold", Page 33</i> <hr/> <p>The temperature is too high.</p> <ul style="list-style-type: none"> ▶ Wait until the temperature has dropped. ▶ → <i>"Cancelling the programme", Page 32</i> <hr/> <p>Water level is too high.</p> <ul style="list-style-type: none"> ▶ Start the Drain programme. <hr/> <p>Power failure.</p> <ul style="list-style-type: none"> ▶ Open the door using the emergency release. → <i>"Emergency release", Page 56</i>
The water is not draining.	<p>Drain pipe or water outlet hose is blocked.</p> <ul style="list-style-type: none"> ▶ Clean the drain pipe and the water outlet hose. <hr/> <p>Drain pipe or water drain hose is caught or jammed.</p> <ul style="list-style-type: none"> ▶ Ensure that the drain pipe and water drain hose are not kinked or trapped. <hr/> <p>Drain pump is blocked.</p> <ul style="list-style-type: none"> ▶ → <i>"Cleaning the drain pump", Page 41</i> <hr/> <p>☒ is activated.</p> <ul style="list-style-type: none"> ▶ Continue the programme by selecting Spin or Drain and pressing ▷☐☐. → <i>"Resuming the programme when the programme status is Rinse Hold", Page 33</i> <hr/> <p>The water outlet hose is connected too high.</p> <ul style="list-style-type: none"> ▶ Install the water outlet hose at a maximum height of 1 metre. <hr/> <p>Pump cover is not correctly assembled.</p> <ul style="list-style-type: none"> ▶ Correctly assemble the pump cover. <hr/> <p>Detergent dosage is too high.</p>

Fault	Cause and troubleshooting
The water is not draining.	<ul style="list-style-type: none"> ▶ Immediate measure: Mix one tablespoon of fabric softener with 0.5 litres of water and pour the mixture into the compartment for manual dosing (not for outdoor clothing, sportswear or items stuffed with down). ▶ If intelligent dosing is activated, reduce the basic dosage → <i>Page 35</i>. ▶ If you dose manually, reduce the amount of detergent for the next washing cycle with the same load.
	<p>Unapproved extension installed on the water drain hose.</p> <ul style="list-style-type: none"> ▶ Remove any unapproved extensions from the water hose. Connecting the appliance
Water is not flowing in. Detergent is not being dispensed.	<p>You have not pressed ▷■■.</p> <ul style="list-style-type: none"> ▶ Press ▷■■.
	<p>The filter in the water inflow is blocked.</p> <ul style="list-style-type: none"> ▶ Clean the water inflow filter.
	<p>The tap is turned off.</p> <ul style="list-style-type: none"> ▶ Turn on the tap.
	<p>The water inlet hose is kinked or jammed.</p> <ul style="list-style-type: none"> ▶ Ensure that the water inlet hose is not kinked or jammed.
The spin cycle runs several times.	<p>The unbalanced load detection system eliminates an imbalance by repeatedly redistributing the laundry.</p> <ul style="list-style-type: none"> ▶ Not a fault – no action required.
	<p>Note: When loading, where possible, place large and small items of laundry together in the drum. Different sized items of laundry distribute themselves better during the spin cycle.</p>
The programme duration changes during the wash cycle.	<p>The programme operation is optimised electronically. This may change the programme duration.</p> <ul style="list-style-type: none"> ▶ Not a fault – no action required.
	<p>The unbalanced load detection system eliminates an imbalance by repeatedly redistributing the laundry.</p> <ul style="list-style-type: none"> ▶ Not a fault – no action required.
	<p>Note: When loading, where possible, place large and small items of laundry together in the drum. Different sized items of laundry distribute themselves better during the spin cycle.</p>
	<p>Foam detection system switches on a rinse cycle if foam build-up is too high.</p>

Fault	Cause and troubleshooting
The programme duration changes during the wash cycle.	<ul style="list-style-type: none"> ▶ Not a fault – no action required.
No water is visible in the drum.	<p>Water is below the visible area.</p> <ul style="list-style-type: none"> ▶ Not a fault – no action required. ▶ Do not add any extra water to the appliance while it is operating.
Drum jerks after the programme starts.	<p>This is caused by an internal motor test.</p> <ul style="list-style-type: none"> ▶ Not a fault – no action required.
Vibrations and movement of the appliance whilst spinning.	<p>Appliance is not correctly aligned.</p> <ul style="list-style-type: none"> ▶ Aligning the appliance
	<p>The appliance feet are not fixed.</p> <ul style="list-style-type: none"> ▶ Secure the appliance feet. Aligning the appliance
	<p>Transit bolts have not been removed.</p> <ul style="list-style-type: none"> ▶ Removing the transit bolts
Drum does not turn, water does not flow in.	<p>Load detection is active.</p> <ul style="list-style-type: none"> ▶ Not a fault – no action required. <p>Note: The load detection can take up to two minutes.</p>
Heavy foam build-up	<p>Detergent dosage is too high.</p> <ul style="list-style-type: none"> ▶ Immediate measure: Mix one tablespoon of fabric softener with 0.5 litres of water and pour the mixture into the compartment for manual dosing (not for outdoor clothing, sportswear or items stuffed with down). ▶ If intelligent dosing is activated, reduce the basic dosage → <i>Page 35</i>. ▶ If you dose manually, reduce the amount of detergent for the next washing cycle with the same load.
i-Dos  i-Dos  cannot be actuated.	<p>Intelligent dosing is not intended for this programme.</p> <ul style="list-style-type: none"> ▶ Not a fault – no action required. <p>Programme progress does not allow intelligent dosing. No remedial action possible.</p>
High spin speed not reached.	<p>A low spin speed is selected.</p> <ul style="list-style-type: none"> ▶ The next time you run a wash cycle, set a higher spin speed. <hr/> <p> is activated.</p> <ul style="list-style-type: none"> ▶ Select the programmes that are suitable for the type of fabric.

Fault	Cause and troubleshooting
High spin speed not reached.	<p>Unbalance load detection system is using a reduced spin speed to eliminate an unbalance.</p> <ul style="list-style-type: none"> ▶ Redistribute the laundry in the drum. <p>Note: Where possible, mix large and small items in the drum. Different sized items of laundry distribute themselves better during the spin cycle.</p> <ul style="list-style-type: none"> ▶ Start the Spin programme.
The spin programme does not start.	<p>Drain pipe or water outlet hose is blocked.</p> <ul style="list-style-type: none"> ▶ Clean the drain pipe and the water outlet hose.
	<p>Drain pipe or water drain hose is caught or jammed.</p> <ul style="list-style-type: none"> ▶ Ensure that the drain pipe and water drain hose are not kinked or trapped.
	<p>The unbalanced load detection system has interrupted the spin cycle because the laundry is unevenly distributed.</p> <ul style="list-style-type: none"> ▶ Redistribute the laundry in the drum. <p>Note: Where possible, mix large and small items in the drum. Different sized items of laundry distribute themselves better during the spin cycle.</p> <ul style="list-style-type: none"> ▶ Start the Spin programme.
Rushing, hissing noise.	<p>Water is flushed under pressure into the detergent drawer.</p> <ul style="list-style-type: none"> ▶ Not a fault – normal operating noise.
Longer, whirring noise before the start of the wash cycle or fabric softening.	<p>Intelligent dosing system dispenses detergent or care products.</p> <ul style="list-style-type: none"> ▶ Not a fault – normal operating noise.
Brief whirring noise after switching on the appliance.	<p>Intelligent dosing system carries out a function test.</p> <ul style="list-style-type: none"> ▶ Not a fault – normal operating noise.
Loud noises during the spin cycle.	<p>Appliance is not correctly aligned.</p> <ul style="list-style-type: none"> ▶ Aligning the appliance
	<p>The appliance feet are not fixed.</p> <ul style="list-style-type: none"> ▶ Secure the appliance feet. Aligning the appliance
	<p>Transit bolts have not been removed.</p> <ul style="list-style-type: none"> ▶ Removing the transit bolts
Banging noises, rattling in the drain pump.	<p>Foreign bodies have got into the drain pump.</p> <ul style="list-style-type: none"> ▶ → <i>"Cleaning the drain pump", Page 41</i>

Fault	Cause and troubleshooting
Slurping, rhythmical suction noise.	<p>The drain pump is active, the detergent solution is pumped out.</p> <ul style="list-style-type: none"> ▶ Not a fault – normal operating noise.
Creasing.	<p>The spin speed is too high.</p> <ul style="list-style-type: none"> ▶ The next time you run a wash cycle, set a lower spin speed. <hr/> <p>The load is too large.</p> <ul style="list-style-type: none"> ▶ The next time you run a wash cycle, reduce the amount of laundry being loaded. <hr/> <p>The wrong programme is selected for the type of fabric.</p> <ul style="list-style-type: none"> ▶ Select the programmes that are suitable for the type of fabric.
The spin result is not satisfactory. The laundry is too wet/too damp.	<p>A low spin speed is selected.</p> <ul style="list-style-type: none"> ▶ The next time you run a wash cycle, set a higher spin speed. ▶ Start the Spin programme. <hr/> <p> is activated.</p> <ul style="list-style-type: none"> ▶ Select the programmes that are suitable for the type of fabric. <hr/> <p>Drain pipe or water outlet hose is blocked.</p> <ul style="list-style-type: none"> ▶ Clean the drain pipe and the water outlet hose. <hr/> <p>Drain pipe or water drain hose is caught or jammed.</p> <ul style="list-style-type: none"> ▶ Ensure that the drain pipe and water drain hose are not kinked or trapped. <hr/> <p>The unbalanced load detection system has interrupted the spin cycle because the laundry is unevenly distributed.</p> <ul style="list-style-type: none"> ▶ Redistribute the laundry in the drum. <p>Note: Where possible, mix large and small items in the drum. Different sized items of laundry distribute themselves better during the spin cycle.</p> <ul style="list-style-type: none"> ▶ Start the Spin programme. <hr/> <p>Unbalance load detection system is using a reduced spin speed to eliminate an unbalance.</p> <ul style="list-style-type: none"> ▶ Redistribute the laundry in the drum. <p>Note: Where possible, mix large and small items in the drum. Different sized items of laundry distribute themselves better during the spin cycle.</p> <ul style="list-style-type: none"> ▶ Start the Spin programme.

Fault	Cause and troubleshooting
Detergent residue on the damp washing.	Detergents may contain water-insoluble substances that deposit on the laundry. ▶ Start the Rinse programme.
	Unsuitable detergent added to the dispenser of the intelligent dosing system. 1. Check whether the detergent used is suitable. → <i>"Detergents and care products", Page 31</i> 2. Drain the dispenser. → <i>"Cleaning the detergent drawer", Page 40</i> 3. Clean the dispenser. 4. Refill the dispenser. → <i>"Filling the dispensers", Page 34</i>
Detergent residue on the dry laundry.	Basic dosage is not correctly adjusted. ▶ If intelligent dosing is activated, reduce the basic dosage → <i>Page 35</i> .
	Detergents may contain water-insoluble substances that deposit on the laundry. ▶ Brush out the laundry after washing and drying. Unsuitable detergent added to the dispenser of the intelligent dosing system. 1. Check whether the detergent used is suitable. → <i>"Detergents and care products", Page 31</i> 2. Drain the dispenser. → <i>"Cleaning the detergent drawer", Page 40</i> 3. Clean the dispenser. 4. Refill the dispenser. → <i>"Filling the dispensers", Page 34</i>
Insufficient cleaning.	Basic dosage is not correctly adjusted. ▶ If intelligent dosing is activated, reduce the basic dosage → <i>Page 35</i> .
	Basic dosage is not correctly adjusted. ▶ If intelligent dosing is activated, adjust the basic dosage → <i>Page 35</i> correctly. Detergent or care products have congealed in dispensers of the intelligent dosing system. 1. Check whether the detergent used is suitable. → <i>"Detergents and care products", Page 31</i> 2. Drain the dispenser. → <i>"Cleaning the detergent drawer", Page 40</i> 3. Clean the dispenser.

Fault	Cause and troubleshooting
Insufficient cleaning.	<p>4. Refill the dispenser. → <i>"Filling the dispensers", Page 34</i></p> <hr/> <p>Unsuitable detergent added to the dispenser of the intelligent dosing system.</p> <p>1. Check whether the detergent used is suitable. → <i>"Detergents and care products", Page 31</i></p> <p>2. Drain the dispenser. → <i>"Cleaning the detergent drawer", Page 40</i></p> <p>3. Clean the dispenser.</p> <p>4. Refill the dispenser. → <i>"Filling the dispensers", Page 34</i></p>
HomeConnect is not working correctly.	<p>Different causes are possible.</p> <p>► Go to www.home-connect.com.</p>
No connection to the home network.	<p>Wi-Fi is switched off. ► → <i>"Activating Wi-Fi on the appliance", Page 38</i></p> <hr/> <p>Wi-Fi is activated but a connection to your home network cannot be established.</p> <p>1. Ensure that the home network is available.</p> <p>2. Reconnect the appliance to the home network. → <i>"Connecting the appliance to a WLAN home network (Wi-Fi) with WPS function", Page 36</i> → <i>"Connecting the appliance to a WLAN home network (Wi-Fi) without WPS function", Page 37</i></p>
Water is leaking out at the water inlet hose.	<p>Water inlet hose is not correctly/securely connected.</p> <p>1. Connect the water supply hose correctly. Connecting the water inlet hose</p> <p>2. Tighten the screw connection.</p>
Water is leaking out at the water outlet hose.	<p>The water outlet hose is damaged. ► Replace the damaged water outlet hose.</p> <hr/> <p>Water outlet hose is not connected correctly. ► Connect the water outlet hose correctly. Water outlet connection types</p>
Odours have formed in the appliance.	<p>Humidity and detergent residue may promote the formation of bacteria. ► → <i>"Cleaning the drum", Page 39</i></p> <p>► If you are not using the appliance, leave the door and detergent drawer open so that residual water can evaporate.</p>

19.1 Emergency release

Releasing the door

Requirement: The drain pump is empty. → Page 41

1. **ATTENTION!** Escaping water may cause material damage.
 - ▶ Do not open the door if you can see water through the glass.
- Pull the emergency release downwards with a tool and release.

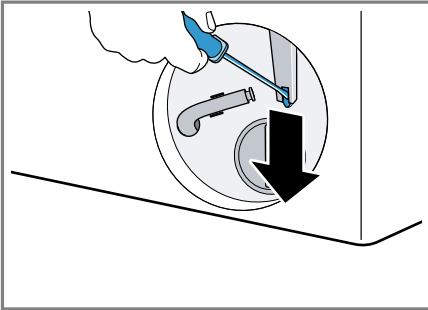

- ✓ The door lock is released.
2. Insert the maintenance flap and lock it into place.
3. Close the maintenance flap.

20 Transportation, storage and disposal

You can find out here how to prepare your appliance for transportation and storage. You will also find out how to dispose of old appliances.

20.1 Removing the appliance

Note: More detailed instructions for use can be found on www.siemens-home.bsh-group.com or by scanning the QR code on the title page of this user manual.

1. Turn off the water tap.
2. Empty the water inlet hose.

3. Switch off the appliance.
4. Unplug the appliance's mains plug.
5. Drain the water.
 - "Cleaning the drain pump", Page 41
6. Detach the hoses.
7. Empty the dispensers.

20.2 Inserting the transit bolts

Secure the appliance for transportation using transit bolts in order to prevent damage.

1. Use a screwdriver to remove the 4 cover caps.

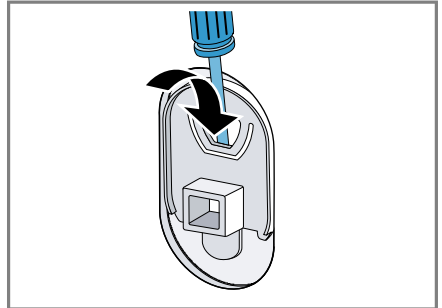

Keep the cover caps.

2. Install the 4 transit bolts. Refer to the description Removing the transit bolts for this and proceed in reverse order.

20.3 Using the appliance again

- ▶ For further information, see
 - "Installation and connection", Page 12 and
 - "Before using for the first time", Page 20.

20.4 Disposing of old appliance

Valuable raw materials can be re-used by recycling.

WARNING

Risk of harm to health!

Children can lock themselves in the appliance, thereby putting their lives at risk.

- ▶ Do not install the appliance behind a door as this may obstruct the appliance door or prevent it from opening.
- ▶ With redundant appliances, unplug the power cord. Then cut through the cord and damage the lock on the appliance door beyond repair so that the appliance door will no longer close.

1. Unplug the appliance from the mains.
2. Cut through the power cord.
3. Dispose of the appliance in an environmentally friendly manner.

Information about current disposal methods are available from your specialist dealer or local authority.



This appliance is labelled in accordance with European Directive 2012/19/EU concerning used electrical and electronic appliances (waste electrical and electronic equipment - WEEE). The guideline determines the framework for the return and recycling of used appliances as applicable throughout the EU.

21 Customer Service

If you have any queries on use, are unable to rectify faults on the appliance yourself or if your appliance needs to be repaired, contact Customer Service.

Function-relevant genuine spare parts according to the corresponding Eco-design Order can be obtained from Customer Service for a period of at least 10 years from the date on which your appliance was placed on the market within the European Economic Area.

Note: Under the terms of the manufacturer's warranty the use of Customer Service is free of charge.

Detailed information on the warranty period and terms of warranty in your country is available from our after-sales service, your retailer or on our website.

If you contact Customer Service, you will require the product number (E-Nr.) and the production number (FD) of your appliance.

The contact details for Customer Service can be found in the enclosed Customer Service directory or on our website.

21.1 Product number (E-Nr.) and production number (FD)

You can find the product number (E-Nr.) and the production number (FD) on the appliance's rating plate. Depending on the model, the rating plate is located:

- On the inside of the door.
- On the inside of the maintenance flap.
- On the rear of the appliance.

Make a note of your appliance's details and the Customer Service telephone number to find them again quickly.

21.2 AQUA-STOP guarantee



In addition to warranty claims against the seller under the purchase agreement and in addition to our manufacturer's warranty, we offer compensation under the following conditions.

- If our Aqua-Stop system is defective and causes water damage, we will make good the damage for private users. To ensure protection from water damage, the appliance must be connected to the power supply.
- The liability guarantee is valid for the service life of the appliance.
- A claim can only be made under the guarantee if the appliance has been correctly installed and connected with Aqua-Stop according to our instructions; this also includes correctly fitting the Aqua-Stop extension (genuine accessory). Our guarantee does not cover defective supply lines or fittings up to the Aqua-Stop connection on the tap.
- If your appliance is fitted with Aqua-Stop, you can in principle leave your appliance unattended during operation and the tap turned on afterwards. The tap only needs to be turned off if you are away from home for a long period, e.g. on holiday for several weeks.

22 Consumption values

The following information is provided in accordance with the EU Ecodesign Regulation. The values given for programs other than the **Eco 40-60** are indicative only and were determined in accordance with the applicable standard EN60456. The automatic dosing function has been deactivated for this purpose.

Note on the comparison test: Deactivate the automatic dosing function unless this function is the object of the test.

Programme	Load (kg)	Programme duration (h:min) ¹	Energy consumption (kWh/cycle) ¹	Water consumption (l/cycle) ¹	Maximum temperature (°C) 5 mins ¹	Spin speed (rpm) ¹	Residual moisture (%) ¹
Eco 40-60 ²	10,0	3:59	1,145	68,0	45	1600	44,00
Eco 40-60 ²	5,0	3:00	0,490	47,0	30	1600	44,00
Eco 40-60 ²	2,5	3:00	0,279	32,0	25	1600	44,00
Cotton 20 °C	10,0	3:23	0,530	94,0	24	1600	43,00
Cotton 40 °C	10,0	3:19	1,420	97,0	45	1600	43,00
Cotton 60 °C	10,0	3:18	2,060	92,0	61	1600	45,00
Cotton 40 °C + 	10,0	3:59	1,450	102,0	43	1600	43,00
Easy Care 40 °C	4,0	2:30	0,760	56,0	49	1200	30,00
Mix 40 °C	4,0	1:05	0,640	42,0	44	1400	50,00
 Wool 30 °C	2,0	0:37	0,171	41,0	23	800	23,00

¹ Due to the influence of water pressure, hardness and inlet temperature, ambient temperature, type, amount and soiling of laundry, detergent used, fluctuations in the power supply and the selected additional functions, the actual values may deviate from the stated values.

² Test programme in accordance with the EU Ecodesign Directive and the EU Energy Labelling Regulation with cold water (15 °C).

23 Technical specifications

Appliance height	84,8 cm
Appliance width	59,8 cm
Appliance depth	63,2 cm
Weight	83,1 kg ¹
Maximum load	10,0 kg
Mains voltage	220-240 V, 50-60 Hz
⚡ Minimum installation protection	10 A
Nominal power	2300 W
Power consumption	<ul style="list-style-type: none"> ▪ Off mode: 0,10 W ▪ Left-on mode: 0,50 W ▪ Time until the networked standby mode is set (Wi-Fi): 5 mins ▪ Networked standby mode (Wi-Fi): 1,20 W
Water pressure	<ul style="list-style-type: none"> ▪ Minimum: 100 kPa (1 bar) ▪ Maximum: 1000 kPa (10 bar)
Length of the water inlet hose	150 cm
Length of the water outlet hose	150 cm
Length of the power cable	210 cm
¹ Depending on the appliance specifications	

This product contains light sources from energy efficiency class F. These light sources are available as a spare part and must only be replaced by trained specialist staff.

You can find more information about your model online at <https://eprel.ec.europa.eu/>¹. This web address is linked to the official EU EPREL product database. Please then follow the instructions on searching for models. The model identifier is made up of the characters before the slash in the product number (E-Nr.) on the rating plate. Alternatively, you can also find the model identifier in the first line of the EU energy label.

24 Declaration of Conformity

BSH Hausgeräte GmbH hereby declares that the appliance with Home Connect functionality conforms to the basic requirements and other relevant provisions of Directive 2014/53/EU.

A detailed RED Declaration of Conformity can be found online at www.siemens-home.bsh-group.com among the additional documents on the product page for your appliance.



Hereby, BSH Hausgeräte GmbH declares that the appliance with Home Connect functionality is in compliance with relevant statutory requirements.

¹ Only applies to countries in the European Economic Area

A detailed Declaration of Conformity can be found online at www.siemens-home.bsh-group.com/uk/ among the additional documents on the product page for your appliance.



2.4 GHz band (2400–2483.5 MHz):
Max. 100 mW
5 GHz band (5150–5350 MHz +
5470–5725 MHz): Max. 100 mW

	BE	BG	CZ	DK	DE	EE	IE	EL	ES
	FR	HR	IT	CY	LI	LV	LT	LU	HU
	MT	NL	AT	PL	PT	RO	SI	SK	FI
	SE	NO	CH	TR	IS	UK (NI)			
5 GHz WLAN (Wi-Fi): For indoor use only.									
AL	BA	MD	ME	MK	RS	UK	UA		
5 GHz WLAN (Wi-Fi): For indoor use only.									

BSH Hausgeräte GmbH

Carl-Wery-Straße 34

81739 München

GERMANY

www.siemens-home.bsh-group.com

Valid within Great Britain:

Imported to Great Britain by

BSH Home Appliances Ltd.

Grand Union House

Old Wolverton Road

Wolverton, Milton Keynes

MK12 5PT

United Kingdom

Manufactured by BSH Hausgeräte GmbH under the trademark licence of Siemens AG



9001639449

(010804)

en